

# TM-2657 series

## Automatic blood Pressure Monitor

### External communication specification

*© 2005 A&D Company Ltd. All rights reserved.*

No part of this publication may be reproduced, transmitted, transcribed, or translated into any language in any form by any means without the written permission of A&D Company Ltd.

The contents of this manual and the specifications of the instrument covered by this manual are subject to change for improvement without notice.

# CONTENTS

<b>1</b>	<b>INTRODUCTION</b> .....	<b>4</b>
1.1	ABOUT THIS MANUAL .....	4
1.2	CORRESPONDING MODEL.....	4
1.3	TERMINOLOGY.....	4
1.4	PROTOCOL .....	5
1.5	TRANSMISSION CONTROL CHARACTERS .....	5
1.6	TM2657 PART NAMES.....	6
1.7	EXTERNAL I / O UNITS BY FUNCTION OVERVIEW .....	7
1.8	FUNCTION SETTING.....	8
<b>2</b>	<b>SYSTEM SUMMARY</b> .....	<b>11</b>
2.1	EXTERNAL I / O UNIT BY THE CONNECTED DEVICE (COMMUNICATION SETTINGS /COMMUNICATION CABLE) LIST.....	11
<b>3</b>	<b>COMMUNICATION SPECIFICATION</b> .....	<b>16</b>
3.1	COMMUNICATION CONNECTOR PIN ASSIGNMENT .....	16
3.2	EXTERNAL I / O SETTING (F20/F21/F22/F23/F24) .....	17
3.3	MEASUREMENT RESULT OUTPUT SETTING (F25) .....	19
3.4	MEASUREMENT RESULT AUTOMATIC OUTPUT FORMAT LIST .....	19
<b>4</b>	<b>COMMUNICATION FORMAT (MEASUREMENT RESULTS AUTOMATIC OUTPUT)</b> .....	<b>20</b>
4.1	BASIC FORMAT .....	20
4.2	MEASUREMENT RESULT AUTOMATIC OUTPUT : RB FORMAT .....	21
4.3	MEASUREMENT RESULT AUTOMATIC OUTPUT : RI FORMAT .....	22
4.4	MEASUREMENT RESULT OUTPUT DATA : BP FORMAT.....	23
4.5	MEASUREMENT RESULT AUTOMATIC OUTPUT : RA FORMAT .....	24
<b>5</b>	<b>COMMUNICATION FORMAT (STD COMMAND)</b> .....	<b>26</b>
5.1	BASIC FORMAT .....	27
5.2	ACK/NAK RESPONSE PACKET .....	27
5.2.1	ACK packet (output direction) TM2657→ external device.....	27
5.2.2	NAK packet (output direction) TM2657→ external device.....	27
5.3	BLOOD PRESSURE MEASUREMENT START (ST) COMMAND.....	28
5.4	BLOOD PRESSURE MEASUREMENT END (SP) COMMAND .....	28
5.5	PRESSURIZATION SETUP VALUE (IP) COMMAND.....	28
5.6	DATE SETTING (YS) COMMAND.....	29
5.7	TIME SETTING (DS) COMMAND.....	29
5.8	THE MEASUREMENT RESULT REQUEST (RB) COMMAND .....	30
5.9	THE MEASUREMENT RESULT REQUEST WITH ID (RB) COMMAND.....	31

5.10	THE MEASUREMENT RESULT REQUEST WITH ID (BP) COMMAND.....	32
5.11	BLOOD PRESSURE RESULT OUTPUT (RA) .....	33
5.12	PULSE WAVE DATA REQUEST (RP) COMMAND .....	35
5.13	<b>REQUEST THE PREVIOUS MEASUREMENT DATA IN RS FORMAT.....</b>	<b>36</b>
5.14	MEASUREMENT NUMBER REQUEST (CT) COMMAND .....	37
5.15	ID REQUEST (ID) COMMAND.....	38
5.16	BPM SERIAL NUMBER REQUEST (BS) COMMAND.....	39
<b>6</b>	<b>COMMUNICATION FORMAT (OTHER COMPANY MEASUREMENT RESULTS AUTOMATIC OUTPUT) .....</b>	<b>40</b>
6.1	MEASUREMENT RESULT AUTOMATIC OUTPUT (UX) FORMAT .....	40
6.2	MEASUREMENT RESULT AUTOMATIC OUTPUT (RVX COMPATIBLE) FORMAT.....	41
6.3	MEASUREMENT RESULT AUTOMATIC OUTPUT (RVY COMPATIBLE) FORMAT .....	42
<b>7</b>	<b>BLUETOOTH (SPP) CONNECTION .....</b>	<b>43</b>
7.1	SYSTEM EXAMPLE .....	43
7.2	PAIRING METHOD.....	44
7.3	EXTERNAL INPUT AND OUTPUT SETTING (F20/F21/F22/F23/F24) .....	45
7.4	MEASUREMENT RESULT OUTPUT SETTING (F25) .....	46
7.5	BLUETOOTH AUTHENTICATION SETTING.....	47
<b>8</b>	<b>BLUETOOTH (CONTINUA) CONNECTION.....</b>	<b>48</b>
8.1	PAIRING.....	49
8.2	MEASUREMENT DATA TRANSMISSION .....	49
8.3	BLUETOOTH UTILITY MODE .....	49
8.4	TIME SYNCHRONIZATION .....	51
8.5	EXTERNAL INPUT-OUTPUT SETTING (F22/F24) .....	52
8.6	MEASUREMENT RESULT OUTPUT SETTING (F31) .....	53
<b>9</b>	<b>ID INPUT.....</b>	<b>54</b>
<b>10</b>	<b>A&amp;D CO.,LTD. HEIGHT AND WEIGHT SCALE CONNECTION .....</b>	<b>56</b>
10.1	SYSTEM EXAMPLE.....	56
10.2	SETTING OF HEIGHT AND WEIGHT VALUE PRINTING.....	57
<b>11</b>	<b>ICT PRINTING.....</b>	<b>59</b>
11.1	ICT PRINTING EXAMPLE (F29) .....	59
11.2	CODE39 BARCODE (V1) DATA FORMAT .....	61
11.3	CODE39 BARCODE (V2) DATA FORMAT .....	61
11.4	QR CODE (V1) DATA FORMAT. ....	62
11.5	QR CODE (V2) DATA FORMAT.....	63
<b>12</b>	<b>ERROR CODE (TM-2657) .....</b>	<b>66</b>
12.1	OVERVIEW OF THE ERROR .....	66

---

# 1 Introduction

---

Thank you for purchasing the automatic blood pressure monitor TM-2657 series.

---

## 1.1 About this manual

This specifications document stipulates the basic data control sequence for smooth communication between the TM2657 and external devices (or Personal computer).

Although we pay the utmost care for the sake of accuracy concerning the contents of this manual, even if the damage due to some errors in the text has occurred, our company is not responsible.

---

## 1.2 Corresponding model

TM2657 series

---

## 1.3 Terminology

Terminology	Definitions
BP	blood pressure
bpm	beat per minute
bps	bit per second
SYS	systolic blood pressure
DIA	diastolic blood pressure
MAP	mean arterial blood pressure
mmHg	Blood pressure unit
NIBP	non-invasive blood pressure
PR	pulse rate
STD	TM-265X (Standard) format refer to "5.Communication format" (STD command)
Zero suppress	Replace the top digit extra "0" in space (0 x 20) 085 → 0 x 20 0x38 0x35
Zero padding	Replace the first digit "0" in space (0 x 30) __1 → 0 x 30 0x30 0x31

---

## 1.4 Protocol

Item	Specification	Factory settings
Main standard	Complies with RS232C	
Transmission format	Full duplex asynchronous communication	
Signal speed	Select from 1200/2400/4800/9600	2400
Data bit length	8bits (7bits)	8bits
Stop bit	Select from 1bit/2bits	1bits
Parity	None (Even)	None
Flow control	None	None
Character code	ASCII	

※Data length (7bits)Parity (Even) is automatically set by selecting the connection partner.

---

## 1.5 Transmission control characters

Symbol	Contents
<b>NUL</b>	0x00
<b>SOH</b>	0x01
<b>STX</b>	0x02
<b>ETX</b>	0x03
<b>EOT</b>	0x04
<b>ENQ</b>	0x05
<b>ACK</b>	0x06

Symbol	Contents
<b>LF</b>	0x0A
<b>CR</b>	0x0D
<b>NAK</b>	0x15
<b>SYN</b>	0x16
<b>RS</b>	0x1E
<b>SP</b>	0x20

※All communication data is the ASCII code.

In addition, numerical data is Printable ascii (ASCII code 0x20~0x7E).

Example : '0' : 0 x 30 , 'R':0x52, '000':0x30 0x30 0x30

## 1.6 TM2657 Part names











	Graphic	No.	Name	Abbreviation
Front		1	[Printer cover open]button	
		2	Printer paper discharge part	
		3	Printer cover	
		4	Power cable	
		5	Systolic pressure display	[SYS disp]
		6	Diastolic pressure display	[DIA disp]
		7	Pulse display	[PUL disp]
		8	Time display	[CLOCK disp]
		9	Measurement status LED	
		10	START/STOP switch	[ST/SP]
		11	Arm cuff	
		12	Arm insertion section	
		13	Emergency STOP switch	[FAST/STOP]
Back		14	Select switch	[SELECT]
		15	▲ switch	[▲]
		16	Counter switch	[COUNT]
		17	Maintainance cover	
		18	Arm cuff	
		19	Arm insertion section	
		20	Armrest	
		21	External I / O unit cover	
		22	Power switch	[POWER]
		23	Pressure inspection opening	
		24	AC INPUT switch	
		25	Security slot	

※TM-2657 External I / O unit (TM2657-01, TM2657-03, TM2657-05 and TM2657-06) can only have one No.21 unit attached..  
 (TM2657-06 is only for Japan domestic version.)

## 1.7 External I / O units by function overview

External I / O unit retains 1ch or 2ch connection terminal as follows.

Applications (communication format) and communication specifications can be changed for each of the communication connections using the function settings on the blood pressure monitor body.

Name (product code)	Appearance	Communication connector	Primary use (It can be changed using setting)	For Japan	For Other countries
External I / O unit RS 2ch (TM2657-01)		Ch1: Mini-DIN 8pin (female) 	<ul style="list-style-type: none"> <li>Output blood pressure results</li> <li>Capture the measurement from the A &amp; D made of the height / weight scale</li> </ul>	Maker option Code SA899	Accessory option
		Ch2: D-Sub 9pin (male) 	<ul style="list-style-type: none"> <li>Output the result of the blood pressure</li> <li>Capture the ID from the ID reader</li> <li>Capture the measurement from the A &amp; D made of the height / weight scale</li> </ul>		
External I / O unit ST (TM2657-03)		Ch1: D-Sub 9pin (male) 	<ul style="list-style-type: none"> <li>Output the result of the blood pressure</li> <li>Capture the ID from the ID reader</li> <li>Capture the measurement from the A &amp; D made of the height / weight scale</li> </ul>	Standard equipment	Accessory option
External I / O unit RS+BT-C (TM2657-05)		Bluetooth Ver.2.1 Power classes:Class1 	<ul style="list-style-type: none"> <li>Output the result /ID of the blood pressure to the following Bluetooth device</li> <li>①Continua (HDP) device</li> <li>②Device corresponding to the A&amp;D(SPP)specification</li> <li>③iPhone,iPad and iPod</li> </ul>	Maker option Code SA900	Accessory option
		Ch1: D-Sub 9pin (male) 	<ul style="list-style-type: none"> <li>Output the result of the blood pressure</li> <li>Capture the ID from the ID reader</li> <li>Capture the measurement from the A &amp; D made of the height / weight scale</li> </ul>		
External I / O unit RS + BT-SPP (TM2657-06)		Built-in : Bluetooth Ver.2.1 (+EDR 2.1/2.0/1.1) Power classes:Class1  Communication distance under 10m	<ul style="list-style-type: none"> <li>It is possible to communicate with other Bluetooth device using SPP(Serial Port Profile)</li> <li>Communication feature / setting is the same treatment as TM2657-01,Ch1.</li> </ul>	Maker option code SA962	Not applicable
		Ch1: D-Sub 9pin (male) 	<ul style="list-style-type: none"> <li>Output the result of the blood pressure</li> <li>Capture the ID from the ID reader</li> <li>Capture the measurement from the A &amp; D made of the height / weight scale</li> </ul>		

TM2657-05/TM2657-06(Bluetooth correspondence table)

OS	Windows				Android				iOS		
	Bluetooth		Bluetooth Low Energy	NFC	Bluetooth		Bluetooth Low Energy	NFC	Bluetooth	Bluetooth Low Energy	NFC
Profile	SPP	HDP	BLE	—	SPP	HDP	BLE	—	—	BLE	—
TM2657-05	●	●	—	—	●	●	—	—	●	—	—
TM2657-06	●	—	—	—	●	—	—	—	—	—	—



## 1.8 Function setting

By using the function setting mode, it is possible to change each of the following functions for each output terminal, "Protocol (F20)", "Communication speed (F21,F22)", "Stop bit (F23,F24)", "Blood pressure result output (F25), concerning the external I / O unit .

### 1) Changing procedure

1. In power off mode, hold both the [▲] and [SELECT] buttons down and switch the power on simultaneously.

F01 is displayed in the systolic display section and the monitor enters the function changing mode.

2. Each time the [SELECT] button is pressed, the setting item changes to F02, F03, ...

3. Each item can be changed using the [▲] button.

4. After completing the settings, switch the power off and then on again.

Setting items	Details	Default	Diastolic display section	Function
F01	Not used	—		
F02	Display time	20	OFF,5,10,20,999	Measurement result display time (seconds)
F03	Applied pressure	Aut	Aut,160,180,200	Applied pressure setting (mmHg)
F04	Not used	—		
F05	IHB	on	OFF/on	IHB-mark printing on/off
F06	Not used	—		
F07	Print quality/ light or dark		OFF	Printing off
			1	Light printing (high speed)
		○	2	Standard printing
			3	Dark high-quality printing (low speed)
F08	ID and name printing		OFF	ID : No / Name : No
		○	1	ID : No / Name : Yes
			2	ID : Yes / Name : No
			3	ID : Yes / Name : Yes
F09	Mean arterial blood pressure (MAP) printing	OFF	OFF/on	Mean arterial blood pressure (MAP) printing on/off
F10	Not used	—		
F11	Measurement value printing		1	High-speed printing
		○	2	Normal 3-line printing
			3	Big font printing
			4	Table printing
F12	Graph printing	○	OFF	Graph printing off
			1	Pulse fluctuation graph printing
F13	Not used	—		
F14	Not used	—		
F15	Bitmap printing	○	OFF	Bitmap printing off
			1	Standard pattern printing
			2	User pattern printing

Setting items	Details	Default	Diastolic display section	Function
<b>F16</b>	Height and weight values printing		OFF	Height and weight values printing OFF
			1	Printer mode printing
		○	2	Integrated mode printing
<b>F17</b>	Not used	—		
<b>F18</b>	Beep sound	on	OFF/on	Beep sound on/off
<b>F19</b>	Not used	—		
<b>F20</b>	External input/output protocol		OFF	No connection
		○	1	Mini-DIN: blood pressure result input/output (STD/RI/RB/BP/RA) D-Sub: blood pressure result input/output (STD/RI/RB/BP/RA)
			2	Mini-DIN: connect to the A&D weight scale D-Sub: blood pressure result input/output (STD/RI/RB/BP/RA)
			3	Mini-DIN: blood pressure result input/output (STD/RI/RB/BP/RA) D-Sub: ID reader
			4	Mini-DIN: blood pressure result input/output (STD/RI/RB/BP/RA) D-Sub: Ux compatibility
			5	Mini-DIN: blood pressure result input/output (STD/RI/RB/BP/RA) D-Sub: RVX compatibility
			6	Mini-DIN: blood pressure result input/output (STD/RI/RB/BP/RA) D-Sub: connect to the A&D weight scale
			7	Mini-DIN: blood pressure result input/output (STD/RI/RB/BP/RA) D-Sub: RVY compatibility
<b>F21</b>	Transmission speed (Mini-DIN)		120	1200 bps
		○	240	2400 bps
			480	4800 bps
			960	9600 bps
<b>F22</b>	Transmission speed (D-Sub)		120	1200 bps
		○	240	2400 bps
			480	4800 bps
			960	9600 bps
<b>F23</b>	Stop bit (Mini-DIN)	○	1	Stop bit: 1
			2	Stop bit: 2
<b>F24</b>	Stop bit (D-Sub)	○	1	Stop bit: 1
			2	Stop bit: 2
<b>F25</b>	Blood pressure result output	○	1	RB (no ID, immediately after measurement) + STD
			2	RI (with ID, immediately after measurement)+ STD
			3	BP (with ID, immediately after measurement)only
			4	STD (command response) only
			5	RA (with ID, immediately after measurement)

<b>F26</b>	Date format	※	<i>EU</i>	DD month., YYYY
			<i>US</i>	month. DD, YYYY
<b>F27</b>	Time format	※	<i>24</i>	24 hour
			<i>12</i>	12 hour (AM/PM)
<b>F28</b>	Not used	—		
<b>F29</b>	ICT printing	○	<i>OFF</i>	ICT printing OFF
			<i>1</i>	Bar code printing (CODE39)
			<i>2</i>	QR code printing, including ID
			<i>3</i>	Bar code printing (CODE39 , with check digit (modulus43) )
		<i>4</i>	QR code printing V2, including ID	
<b>F31</b>	Bluetooth connection timing	○	<i>1</i>	Connection at the end of measurement
			<i>2</i>	Connection at the start of measurement















※F16 setting is valid only if F20 setting is 2 or 6.

※ The default setting depends on the destination.

To reset all settings to factory settings, hold the **START/STOP** button for 5 seconds when any of the “**FXX**” numbers are displayed.

## 2 System summary

### 2.1 External I / O unit by the connected device (Communication settings /communication cable) list

External I / O unit	Connection terminal example  Communication connector fojiguration	FeliCa Reader terminal	Barcode Touch scanner	Magnetic card reader	PC												
		UFT-N103S(WE) 	1000R-S09 	PDC-816RL 	— 												
TM2657-01 	Mini-DIN 8pin female 	x	x	x	oConnection cable AX-KO1869												
	D-Sub 9pin male 	o(F20=3)	o(F20=3)	o(F20=3)	o*General crossover cable or dedicated cable AX-KO1371-200												
TM2657-03 	—	—	—	—	—												
	D-Sub 9pin male 	o(F20=3)	o(F20=3)	o(F20=3)	o*General crossover cable or dedicated cable AX-KO1371-200												
TM2657-05 	Built-in : Bluetooth Ver.2.1 Class1 HDP correspondence 	—	—	—	oBluetooth device oContinua (HDP) oA&D( SPP ) device												
	D-Sub 9pin male 	o(F20=3)	o(F20=3)	o(F20=3)	o*General crossover cable or dedicated cable AX-KO1371-200												
TM2657-06 	Built-in : Bluetooth Ver.2.1 Class2 SPP correspondence	—	—	—	oWith Bluetooth function SPP correspondence												
	D-Sub 9pin male 	o(F20=3)	o(F20=3)	o(F20=3)	o*General crossover cable or dedicated cable AX-KO1371-200												
※Notice		※Investigate in advance,such as Felica card specification of the user, you need to change the firmware in the terminal. It functions as the ID reader.	※Equivalent allowed - TM-2657 D-SUB communication setting-  Baud rate <b>F22</b> (1200/2400/4800/9600) Start bit 1 (fix) Data length 8 (fix) Parity None (fix) Stopbit <b>F24</b> (1 / 2) -Data transmission format of the reader- <table border="1" data-bbox="865 1733 1209 1998"> <tr> <td rowspan="4">Data transmission format</td> <td>Prefix</td> <td>None</td> </tr> <tr> <td>Code ID</td> <td>None</td> </tr> <tr> <td>Data digit number</td> <td>None</td> </tr> <tr> <td>Barcode data</td> <td>1~16 digits</td> </tr> <tr> <td>Postfix</td> <td>CR (0D)</td> <td></td> </tr> </table>		Data transmission format	Prefix	None	Code ID	None	Data digit number	None	Barcode data	1~16 digits	Postfix	CR (0D)		※Communication format F20:measurement result output setting F25:blood pressure result output setting 1)RB +STD 2)RI +STD 3)BP 4)STD ( command response) 5)RA+STD
Data transmission format	Prefix	None															
	Code ID	None															
	Data digit number	None															
	Barcode data	1~16 digits															
Postfix	CR (0D)																

\* General crossover cable : Null modem cable

## System example

The following system connection example for each external I / O unit indicates the operation and data flow timing to the left, and shows the example of the setting of each channel to the left.

### 1) External I / O unit RS 2ch (TM2657-01)

⊙ID reader, PC connecting

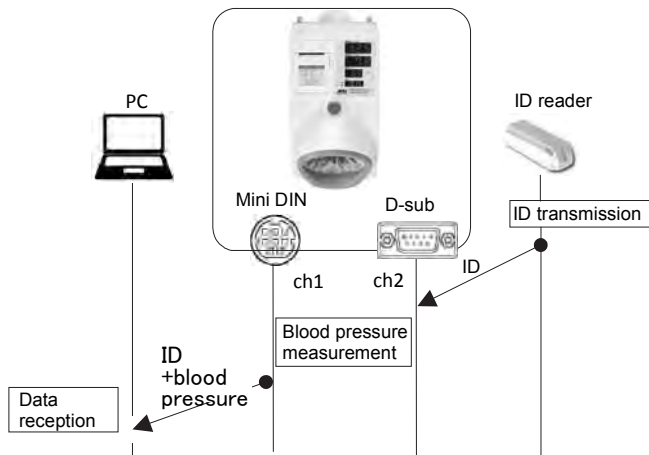

#### [Function setting]

Connecting device **F20:[ 3 ]** ch1:Measurement result output ch2:ID reader

Measurement result output setting

**F25** ( RB / RI / BP / STD / RA )

#### [ch1 Communication setting]

Baud rate **F21** ( 1200 / 2400 / 4800 / 9600 )

Start bit 1 (fix)

Data length 8 (fix)

Parity None (fix)

Stop bit **F23** ( 1 / 2 )

#### [ch2 Communication setting]

Baud rate **F22** ( 1200 / 2400 / 4800 / 9600 )

Start bit 1 (fix)

Data length 8 (fix)

Parity None (fix)

Stop bit **F24** ( 1 / 2 )

※ In the case No ID reader connection, ID information in the blank.

⊙Height weight scale, PCconnecting

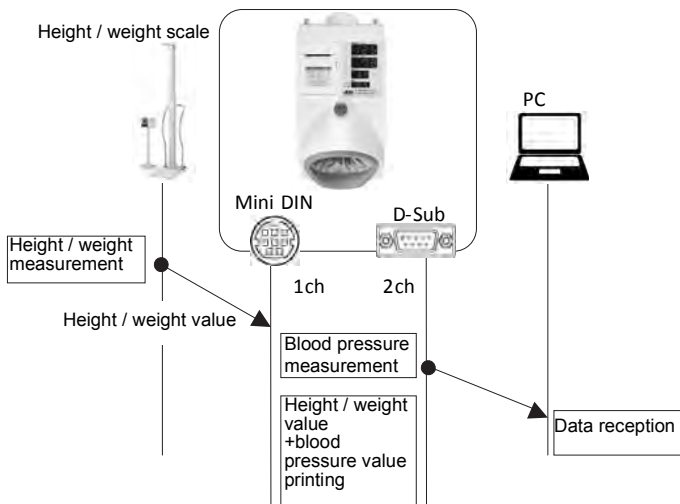

#### [Function setting]

Connecting device **F20:[ 2 ]** ch1:Height weight scale

ch2:measurement result output

Measurement result output setting **F25** ( RB / RI / BP / STD / RA )

#### [ch1 communication setting]

Baud rate 2400 (fix)

Start bit 1 (fix)

Data length 7 (fix)

Parity Even (fix)

Stop bit **F23** ( 1 / 2 )

#### [ch2 communication setting]

Baud rate **F22** ( 1200 / 2400 / 4800 / 9600 )

Start bit 1 (fix)

Data length 8 (fix)

Parity None (fix)

Stop bit **F24** ( 1 / 2 )

## 2) External I / O unit ST (TM2657-03)

### ①PC connection

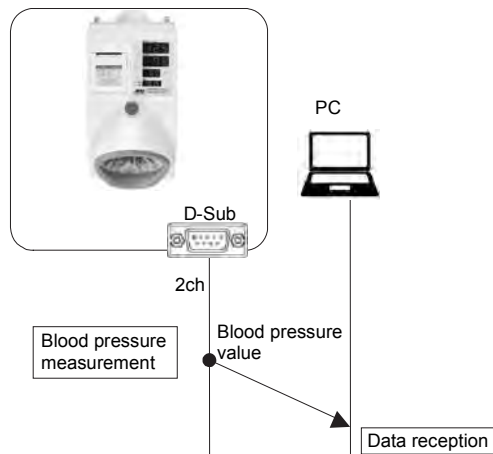

#### [Function setting]

Connecting device **F20:[ 1 ]** ch1: --- ch2:Measurement result output  
Measurement result output setting **F25** (RB / RI / BP / STD/ RA )

#### [ch1 communication setting]

Baud rate ---  
Start bit ---  
Data length ---  
Parity ---  
Stop bit ---

#### [ch2 communication setting]

Baud rate **F22** ( 1200 / 2400 / 4800 / 9600 )  
Start bit 1 (fix)  
Data length 8 (fix)  
Parity None (fix)  
Stop bit **F24** ( 1 / 2 )

©ID reader connecting

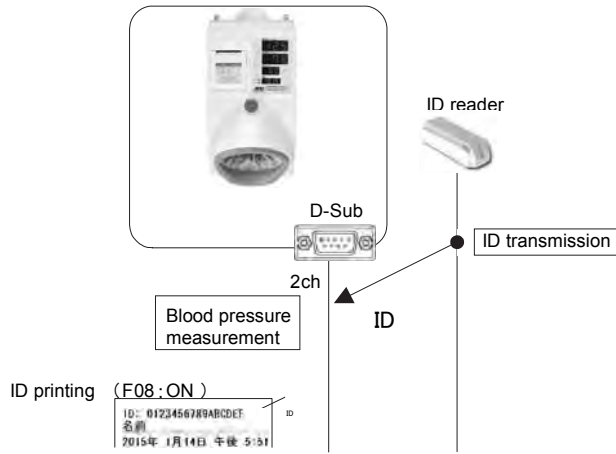

[Function setting]

Connecting device **F20:[ 3 ]** ch1: --- ch2:ID reader  
 Measurement result output setting ---

[ch1 communication setting]

Baud rate ---  
 Start bit ---  
 Data length ---  
 Parity ---  
 Stop bit ---

[ch2 communication setting]

Baud rate **F22** (1200 / 2400 / 4800 / 9600 )  
 Start bit 1 (fix)  
 Data length 8 (fix)  
 Parity None (fix)  
 Stop bit **F24** (1 / 2)

### 3) External I / O unit RS+BT-C (TM2657-05)

○ID reader, PC (Bluetooth/Continua) connecting

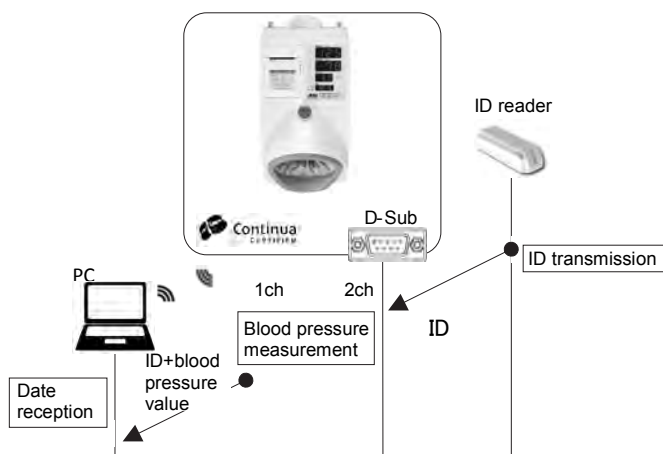

※ ID information column is filled by blank character.

#### [Function setting]

Function setting **F20:[ 3 ]** ch1:Measurement result output  
 ch2:ID reader  
 Measurement result output setting ---

#### [ch1 communication setting]

Baud rate --- for BT communication  
 Start bit ---  
 Data length ---  
 Parity ---  
 Stop bit ---

#### [ch2 communication setting]

Baud rate **F22** (1200 / 2400 / 4800 / 9600 )  
 Start bit 1 (fix)  
 Data length 8 (fix)  
 Parity None (fix)  
 Stop bit **F24** (1 / 2)

### 4) External I / O unit RS+BT-SPP (TM2657-06)

○ID reader, PC (Bluetooth/SPP) connecting

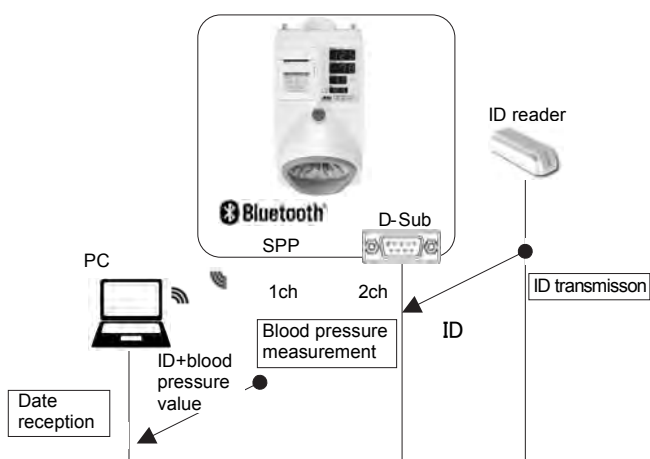

※ID information column is filled by blank character.

#### [Function setting]

Connecting device **F20:[ 3 ]** ch1: Measurement result output  
 setting ch2:ID reader  
 Measurement result output setting **F25** ( RB / RI / BP / STD /  
 RA )

#### [ch1 communication setting]

Baud rate **F21** (1200 / 2400 / 4800 / 9600 )  
 Start bit 1 (fix)  
 Data length 8 (fix)  
 Parity None (fix)  
 Stop bit **F23** (1 / 2)

#### [ch2 communication setting]

Baud rate **F22** (1200 / 2400 / 4800 / 9600 )  
 Start bit 1 (fix)  
 Data length 8 (fix)  
 Parity None (fix)  
 Stop bit **F24** (1 / 2)



# 3 Communication specification

## 3.1 Communication connector pin assignment

1) Mini-DIN 8pin female



Pin No.	Signal name	Description
1	T X D	Transmit data
2	R X D	Receive data
3	R T S	Request to send
4	Reserve	No connection
5	C T S	Clear to send
6	G N D	Signal ground
7	Foot switch	When short-circuited to the GND, the measurement starts.
8	Coin specification	When short-circuited to the GND, the measurement is allowed only once.

### Cable specification for computer connection

TM-2657P

Mini-Din 8 pin female

Personal computer or ID Reader

D-sub 9pin male

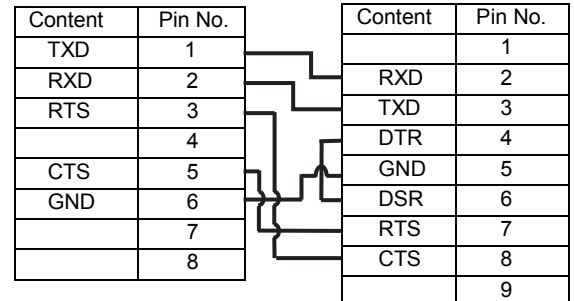

- ※ Do not connect to Pins No. 4, 7, or 8. They are used for the blood pressure monitor.
- ※ If it is to connect with the general DOS/V personal computer, please connect with a dedicated communication cable (AX-KO1869).

2) D-Sub 9pin Male



Pin number	Signal name	Function
1	-	
2	R X D	Receive data
3	T X D	Transmit data
4	(D T R)	Data terminal ready (Short-circuit the 6pin)
5	G N D	Signal ground
6	(D S R)	Data set ready (Short-circuit the 4pin)
7	R T S	Request to send
8	C T S	Clear to send
9	-	

### Cable connection between the device and a personal computer

TM-2657P

D-Sub 9pin male

Personal computer or ID Reader

D-sub 9pin male

D-sub connector

D-sub connector

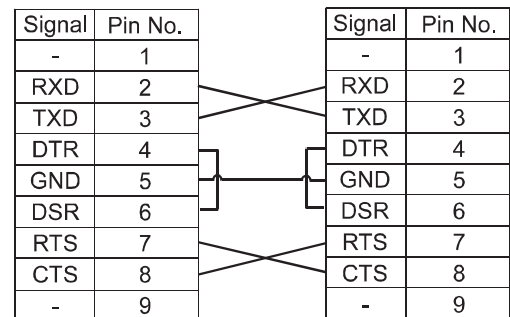



- ※ If it is connected using a general DOS/V PC, confirm the pin assignment and connect using a general cross cable (null modem cable) or a dedicated communication cable (AX-KO1371-200).

## 3.2 External I / O setting (F20/F21/F22/F23/F24)

It can be changed to suit the transmission and reception function of CH1/CH2 by the combination of external I/O unit and function setting F20 setting.

Also, CH1/CH2 of the baud rate, stop bits can be changed by the setting of the F21/F22, F23/f24.

Option 1 (TM2657-01)		CH1 					CH2 				
F20	Description	Function	Baudrate	Databit	Parity	Stopbit	Function	Baudrate	Databit	Parity	Stopbit
OFF	No external output	No external output	No communication				No external output	No communication			
1	CH1: Measurement result output CH2: Measurement result output	Measurement result output	F21	8	None	F23	Measurement result output	F22	8	None	F24
2	CH1: A&D Height weight scale CH2: Measurement result output	A&D Height weight scale	* 2400	7	Even	F23	Measurement result output	F22	8	None	F24
3	CH1: Measurement result output CH2: ID reader	Measurement result output	F21	8	None	F23	ID reader	F22	8	None	F24
4	CH1: Measurement result output CH2: Ux compatible	Measurement result output	F21	8	None	F23	Ux compatible	F22	8	Even	* 2
5	CH1: Measurement result output CH2: RVX compatible	Measurement result output	F21	8	None	F23	RVX compatible	* 2400	7	Even	* 1
6	CH1: Measurement result output CH2: A&D Height weight scale	Measurement result output	F21	8	None	F23	A&D height weight scale	* 2400	7	Even	F24
7	CH1: Measurement result output CH2: RVY compatible	Measurement result output	F21	8	None	F23	RVY compatible	* 2400	8	Even	* 1

Option 3 (TM2657-03)		CH1					CH2 				
F20	Description	Function	Baudrate	Databit	Parity	Stopbit	Function	Baudrate	Databit	Parity	Stopbit
OFF	No external output	None	CH1 No implementation				No external output	No communication			
1	CH1: Measurement result output CH2: Measurement result output						Measurement result output	F22	8	None	F24
2	CH1: A&D Height weight scale CH2: Measurement result output						Measurement result output	F22	8	None	F24
3	CH1: Measurement result output CH2: ID reader						ID reader	F22	8	None	F24
4	CH1: Measurement result output CH2: Ux compatible						Ux compatible	F22	8	Even	* 2
5	CH1: Measurement result output CH2: RVX compatible						RVX compatible	* 2400	7	Even	* 1
6	CH1: Measurement result output CH2: A&D Height weight scale						A&D height weight scale	* 2400	7	Even	F24
7	CH1: Measurement result output CH2: RVY compatible						RVY compatible	* 2400	8	Even	* 1

Option 5 (TM2657-05)		CH1				CH2 					
F20	Description	Function	Baudrate	Databit	Parity	Stopbit	Function	Baudrate	Databit	Parity	Stopbit
OFF	No external output	Bluetooth	No communication				No communication				
1	CH1: Measurement result output CH2: Measurement result output		Communication setting is not affected by F20 (9600, 8, N, 1)				Measurement result output	F22	8	None	F24
2	CH1: A&D Height weight scale CH2: Measurement result output						Measurement result output	F22	8	None	F24
3	CH1: Measurement result output CH2: ID reader						ID reader	F22	8	None	F24
4	CH1: Measurement result output CH2: Ux compatible						Ux compatible	F22	8	Even	* 2
5	CH1: Measurement result output CH2: RVX compatible						RVX compatible	* 2400	7	Even	* 1
6	CH1: Measurement result output CH2: A&D Height weight scale						A&D height weight scale	* 2400	7	Even	F24
7	CH1: Measurement result output CH2: RVY compatible						RVY compatible	* 2400	8	Even	* 1

- Databit, Parity is fixed depending on the setting of the F20(not selected).
- The setting variation (baud rate) of F21 and F22 is one of the "1200,2400,4800,9600".
- The setting variation (stop bit) of F23 and F24 is either "1" or "2".
- "\*" Item is fixed, regardless of the setting of the"F21,F22 or F24.
- The measurement result output format can be selected in F25(refer to the next page).

### 3.3 Measurement result output setting (F25)

Measurement result output setting		Automatic output format immediately after measured	PC command (STD) response Possible/Impossible
F25	Description		
1	RB (No ID, immediately after measured) + STD	RB (No ID, immediately after measured)	Possible
2	RI (With ID, immediately after measured) + STD	RI (With ID, immediately after measured)	Possible
3	BP (With ID, immediately after measured)	BP (With ID, immediately after measured)	Impossible
4	STD (command response)	No automatic output	Possible
5	RA (With ID, immediately after measured) + STD	RA (With ID, immediately after measured)	possible

### 3.4 Measurement result automatic output format list

Item	Input command				Remarks
	RB	RI	BP	RA	
ID		○	○	○	Max 16 digit
Measurement start date and time	○	○	○	○	Current date and time if there is no measurement value YYMMDD hh:mm
Measurement mode(MD)	○			○	Manual measurement "M" or Remote measurement "R"
Error code	○	○		○	At normal end "E00"
Systolic blood pressure	○	○	○	○	SYS
Mean arterial blood pressure	○			○	MAP
Diastolic blood pressure	○	○	○	○	DIA
Pulse rate	○	○	○	○	PUL
Pressurization setup value	○			○	The pressurization target value at the start of the measurement
Maximum pulse amplitude	○			○	The maximum amplitude value of the detected the pulse during measurement
Maximum pulse pressure				○	The maximum pressure value detected during measurement
IHB count value				○	IHB(Irregular Heart Beat) 0~15 times
Body motion				○	The presence or absence of body only(1 or 0). The number does not appear.
Re-measurement count value				○	Number of re-measure times
Measurement time				○	Measurement time to take blood pressure
SW				○	Whether the right or left of the switch has been pressed* "n" except for TM2656
Arm circumference				○	Unused (It has a space in)
Body height value				○	unit : [cm]
Sitting height value				○	unit : [cm]
Body weight				○	unit : [kg]
Tare weight value				○	unit : [kg]
Preset tare value				○	unit : [kg]
BMI				○	Body Mass index

# 4 Communication format (Measurement results automatic output)

## 4.1 Basic format

The blood pressure results automatic output data is output to an external device without an external request only once immediately after measurement. The basic format of the measurement results automatic output data is in this format can be selected from either BP, RA or RI formats by setting the blood pressure result output to F25.

**※The basic format of the measurement results automatic output data**

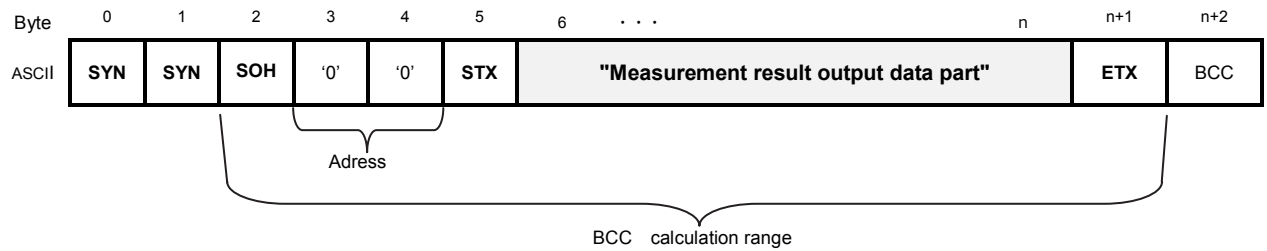

※BCC is the lower 8bits by the results of the XOR on a bit-by-bit basis range of characters between SOH and ETH.

※Byte 3-4 : Address is fixed with '0' '0' (0 x 30, 0 x 30).

**※Measurement result output data (Blood pressure result output setting F25) list**

Section No.	Measurement result output data types	Contents	Remarks	F25 setting
4.2	RB format	Without ID measurement result	Old model (TM-2655 interchangeable)	「1」 ※factory settings
4.3	RI format	With ID measurement result	Old model (TM-2655 interchangeable)	「2」
4.4	BP format	With ID measurement result	Old model (TM-2655 ineterchangeable)	「3」
4.5	RA format	Measurement result data (full data)		「5」

Communication flow example) the case of F25:5"RA+STD command input and output"

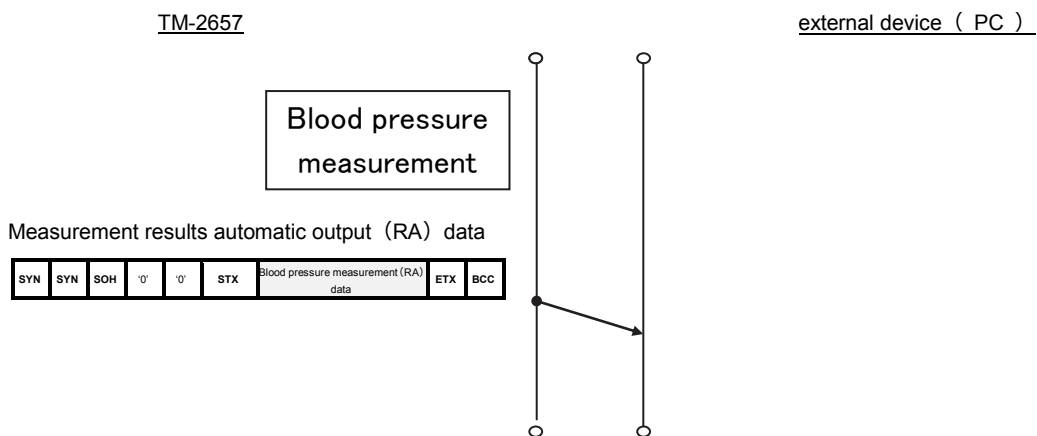

## 4.2 Measurement result automatic output : RB format

If the blood pressure result output setting F25 is set to "1", the measurement result basic format (see 4.1) containing RB format is automatically outputted only once after measurement.

Output direction) TM2657 → external device

Byte	0	1	2	3	4	5	6	7	8	9	10	11	12	13	14	15
ASCII	'T'	'M'	'2'	'6'	'5'	'5'	RS	yy		mm		dd		HH		MM→
	16	17	18	19	20	21	22	23	24	25	26	27	28	29	30	31
	←MM	RS	'R'	'B'	RS	m	RS	'E'	ee	RS	'S'	sys				RS
	32	33	34	35	36	37	38	39	40	41	42	43	44	45	46	47
	'M'		map		RS	'D'		dia		RS	'P'		pul		RS	'I'
	48	49	50	51	52	53	54	55								
		ii	RS	'L'		III										RS

※Stored value by the state:

Identifier	Byte	Normal time of the blood pressure measurement	Abnormal time of the blood pressure measurement
yy	2	<Measurement start time>yymmddHHMM yy : To store the year the last two digits. The setting range is from '15' to '50'. mm : To store the value of the month. The setting range is from '01' to '12'. dd : To store the value of the day. The setting range is from '01' to '31'. HH : To store the value of the current time. The setting range is from '00' to '23'. MM : To store the value of the current minute. The setting range is from '00' to '59'. ※Zero padding Ex) '01' : 0x30 0x31	
mm	2		
dd	2		
HH	2		
MM	2		
m	1	<Mode> 'R': Remote measurement, 'M': Manual measurement	
ee	2	'00' : 0x30 0x30	<Blood pressure measurement error code> ※Refer to the appendix for error code ※Zero padding
sys	3	<Measurement result> sys(S) : Systolic blood pressure [mmHg] map(M) : Mean arterial blood pressure [mmHg] dia(D) : Diastolic blood pressure [mmHg] pul (P): Pulse rate[bpm] ※Zero suppression	<Measurement result error> '000' : 0x30 0x30 0x30
map	3		
dia	3		
pul	3		
ii	2	<Pressurization setup value> [mmHg/10] Store the value of the pressurization value set by dividing by 10. 160mmHg:'16', 180mmHg:'18', 200mmHg:'20', AUTO:'00'	
III	3	<Maximum pulse amplitude > [mmHg] ※Zero suppression Maximum value : '999'	

## 4.3 Measurement result automatic output : RI format

If the blood pressure result output setting F25 is set to "2", the measurement result basic format (see 4.1) containing RI format is automatically outputted only once after measurement.

Output direction) TM2657 → external device

Byte	0	1	2	3	4	5	6	7	8	9	10	11	12	13	14	15
ASCII	'T'	'M'	'2'	'6'	'5'	'5'	RS	yy	mm	dd	HH	MM→				
	16	17	18	19	20	21	22	23	24	25	26	27	28	29	30	31
	←MM	RS	'R'	'I'	RS	id→										
	32	33	34	35	36	37	38	39	40	41	42	43	44	45	46	47
	←id				RS	'E'	ee	RS	sys			RS	dia→			
	48	49	50	51	52	53										
	←dia	RS	pul		RS											

※Stored value by the state:

Identifier	Byte	Normal time of the blood pressure measurement	Abnormal time of the blood pressure measurement
yy	2	<Measurement start time >yymmddHHMM yy : To store the year the last two digits. The setting range is from '15' to '50'. mm : To store the value of the month. The setting range is from '01' to '12'. dd : To store the value of the day. The setting range is from '01' to '31'. HH : To store the value of the current time. The setting range is from '00' to '23'. MM : To store the value of the current minute. The setting range is from '00' to '59'. ※Zero padding Ex) '01' : 0x30 0x31	
mm	2		
dd	2		
HH	2		
MM	2		
id	16	<Mesurer ID> 16-digit fixed. It is stored in the left-justified. Digits less than 16 digits are filled with SP(0x20). If the ID is not read, the ID is SP(0x20).	
ee	2	'00' : 0x30 0x30	<Blood pressure measurement error code> ※Refer to the appendix for error code ※Zero padding
sys	3	<Measurement result> sys(S) :Systolic blood pressure [mmHg] dia(D) :Diastolic blood pressure [mmHg] pul (P): Pulse rate [bpm] ※Zero suppression	<Measurement result error> '000' : 0x30 0x30 0x30
dia	3		
pul	3		

## 4.4 Measurement result output data : BP format

If the blood pressure result output setting F25 is set to "3", the measurement result basic format (see 4.1) containing BP format is automatically outputted only once after measurement.

Output direction) TM2657 → external device

Byte	0	1	2	3	4	5	6	7	8	9	10	11	12	13	14	15	
ASCII	'B'	'P'	id →														
	16	17	18	19	20	21	22	23	24	25	26	27	28	29	30	31	
	← id		yy		mm		dd		HH		MM		sys			dia→	
	32	33	34	35	36	37											
	← dia		pul		NUL												

※Stored value by the state:

Identifier	Byte	Normal time of the blood pressure measurement	Abnormal time of the blood pressure measurement
id	16	<Mesurer ID> 16-digit fixed. It is stored in the left-justified. Digits less than 16 digits are filled with SP(0x20). If the ID is not read, the ID is SP(0x20).	
yy	2	<Measurement start time >yymmddHHMM yy : To store the year tha last two digits. The setting range is from '15' to '50'. mm : To store the value of the month. The setting range is from '01' to '12'. dd : To store the value of the day. The setting range is from '01' to '31'. HH : To store the value of the current time. The setting range is from '00' to '23'. MM : To store the value of the current minute. The setting range is from '00' to '59'. ※Zero padding Ex) '01' : 0x30 0x31	
mm	2		
dd	2		
HH	2		
MM	2		
sys	3	<Measurement result> sys : Maximum blood pressure [mmHg] dia : Minimum blood pressure [mmHg] pul : Pulse rate [bpm] ※Example of the Zero suppression) '90' : 0x20 0x39	<Mesurement result error> '000' : 0x30 0x30 0x30
dia	3		
pul	3		



## 4.5 Measurement result automatic output : RA format

If the blood pressure result output setting F25 is set to "5", the measurement result basic format (see 4.1) containing RA format is automatically outputted only once after measurement.

Output direction) TM2657 → external device

Byte	0	1	2	3	4	5	6	7	8	9	10	11	12	13	14	15
ASCII	'T'	'M'	'2'	'6'	'5'	model	RS	yy	mm	dd	HH	MM	→			
	16	17	18	19	20	21	22	23	24	25	26	27	28	29	30	31
	←MM	RS	'R'	'A'	RS	md	RS	'E'	ee	RS	'S'	sys	RS			
	32	33	34	35	36	37	38	39	40	41	42	43	44	45	46	47
	'M'	map	RS	'D'	dia	RS	'P'	pul	RS	'I'						
	48	49	50	51	52	53	54	55	56	57	58	59	60	61	62	63
	ii	RS	'L'	lll	RS	'p'	mprs	RS	'i'	ihb						
	64	65	66	67	68	69	70	71	72	73	74	75	76	77	78	79
	RS	'm'	motn	RS	'r'	rem	RS	't'	mt	RS	'c'	dir	RS	'l'		
	80	81	82	83	84	85	86	87	88	89	90	91	92	93	94	95
	cuff	RS	'd'	id→												
	96	97	98	99	100	101	102	103	104	105	106	107	108	109	110	111
	←id	RS	'h'	hei	RS	's'	sit→									
	112	113	114	115	116	117	118	119	120	121	122	123	124	125	126	127
	←sit	RS	'w'	wei	RS	'f'	tr→									
	128	129	130	131	132	133	134	135	136	137	138	139	140	141	142	143
	←tr	RS	'e'	pt	RS	'b'	bmi→									
	144	145														
	←bmi	RS														

※Stored value by the state:

Identifier	Byte	Normal time of the blood pressure measurement	Abnormal time of the blood pressure measurement
model	1	<model identify> TM2656:'6', TM2657:'7'	
yy	2	<Measurement start time>yymmddHHMM yy : To store the year the last two digits. The setting range is from '15' to '50'. mm : To store the value of the month. The setting range is from '01' to '12'. dd : To store the value of the day. The setting range is from '01' to '31'. HH : To store the value of the current time. The setting range is from '00' to '23'. MM : To store the value of the current minute. The setting range is from '00' to '59'. ※Zero padding Ex) '01' : 0x30 0x31	
mm	2		
dd	2		
HH	2		
MM	2		
md	1	<Mode> 'R': Remote measurement, 'M':Manual measurement	
ee	2	'00' : 0x30 0x30	<Blood pressure measurement error code> ※Zero padding
sys(S)	3	<Measurement result> sys(S) : Systolic blood pressure [mmHg] map(M) : Mean arterial pressure [mmHg] dia(D) : Diatolic blood pressure [mmHg] pul (P) : Pulse rate [bpm] ※Zero suppression	
map(M)	3		
dia(D)	3		
pu(P)	3		
ii(I)	2	<Pressurization setup value> [mmHg/10] Store the value of the pressurization value set by dividing by 10. 160mmHg:'16'、180mmHg : '18'、200mmHg:'20'、AUTO : '00'	
III(L)	3	<Maximum pulse amplitude> [mmHg] ※Zero suppression Maximum value : '999'	
mprs(p)	3	<Maximum pressure> (200msec main detect)[mmHg] ※Zero suppression	
ihb(i)	2	<Irregular pulse number> [times] '0':no detect '1'~'15' The number of times of detection ※Zero suppression	' '(2 space)
motn(m)	1	<Motion detection> '0':No '1':Yes	' '(1 space)
rems(r)	1	<Re-measure the number of times> [times]	
mt(t)	3	<Blood pressure measurement time> [seconds] ※Zero suppression	
dir(c)	1	<Measurement start switch conditions> L:left R:right N:no distinction	
cuff(l)	2	<information around the arm> [cm] ※ currently not measured, space fixed 0x20 0x20	
id(d)	16	<Measurer ID> 16-digit fixed. It is stored in the left-justified. Digits less than 16 digits are filled with SP(0x20). If the ID is not read, the ID is SP(0x20).	
hei(h)	5	<Height value>'xxx.x'[cm] ※Zero suppression No measured value " "(5 space)	
sit(s)	5	<Sitting height value>'xxx.x'[cm] ※Zero suppression No measured value " "(5 space)	
wei(w)	6	<Weight value>'xxx.x ' or 'xxx.xx'[kg] ※If the decimal point one digit, second digit stores <b>SP</b> (0x20). No measured value " "(6 space)	
tr(f)	6	<Tare value>'xxx.x ' or 'xxx.xx'[kg] ※If the decimal point one digit, second digit stores <b>SP</b> (0x20). No measured value " "(6 space)	
pt(e)	6	<Preset tare value>'xxx.x ' or 'xxx.xx'[kg] ※If the decimal point one digit, second digit stores <b>SP</b> (0x20). No measured value " "(6 space)	
bmi(b)	5	<BMI> 'xxx.x' ※Zero suppression No measured value " "(5 space)	

※ In the case of TM2657, dir(c) measurement start switch conditions is always the 'N'.

# 5 Communication format (STD command)

If the blood pressure result output format setting F25 is set to "4" (STD command input and output), the STD command is received from the external equipment, and a response in accordance with the command is sent.

STD command has two types. One is the setting request command, and the other is the result request command.

In response to a setting request command, one of the sections 5.2 AKD/NAK response packets is sent, and response data in response to the result request command is sent.

STD command list

Described number	Type	Request command	Contents	Response	Remarks
5.3	Setting request command	ST	Blood pressure measurement start	ACK/NAK response packet	Common comand with TM-2655
5.4		SP	Blood pressure measurement stop		
5.5		IP	Pressurization value set		
5.6		YS	Date set		
5.7		DS	Time set		
5.8	Result request command	RB	Measurement result request	RB response data	Common comand with TM-2655
5.9		RI	ID with a measurement result request	RI response data	Common comand with TM-2655
5.10		BP	ID with a measurement result request	BP response data	Common comand with TM-2655
5.11		RA	Measurement result request	RA response data	TM-2657 only
5.12		RP	Pulse wave data(debugging only)	RP response data	Common comand with TM-2655
5.13		RS	State request of blood pressure monitor	RS response data	Common comand with TM-2655
5.14		CT	The measurement number request	CT response data	Common comand with TM-2655
5.15		ID	ID request	ID response data	Common comand with TM-2655
5.16		BS	BPM serial number request	BS response data	TM-2657 only

Communication flow example) In the case of "F25:5 (RA+STD command Input and Output) "

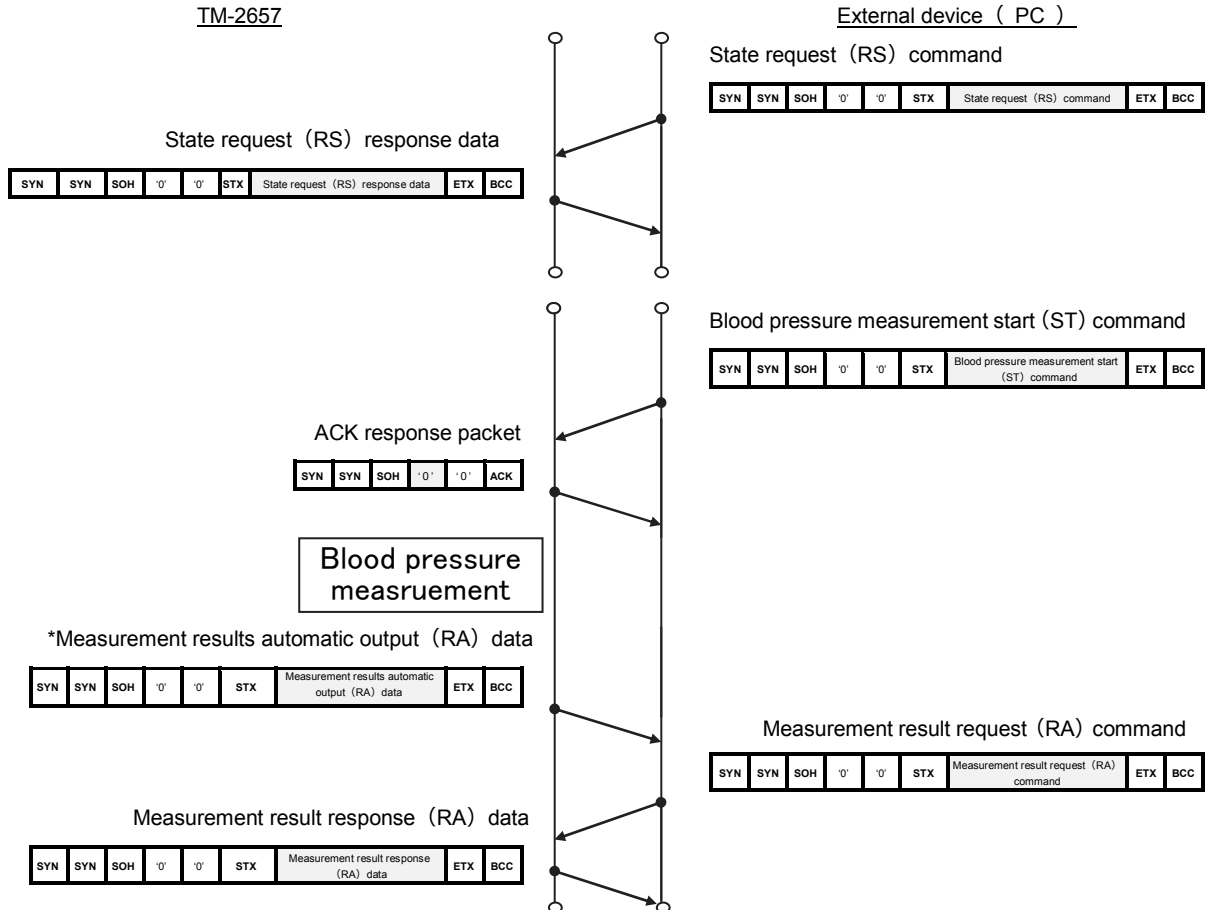

\*TM-2657 returns the response data to the request command from the external device(PC) except for the measurement result automatical out put(RA).

## 5.1 Basic format

When setting request commands, the basic format of the result request command is as follows.

Also, the response data for each result request command uses this basic format.

For the "request/response data part" in this basic format, refer to 5.3 through 5.15.

### ※Basic format for STD command

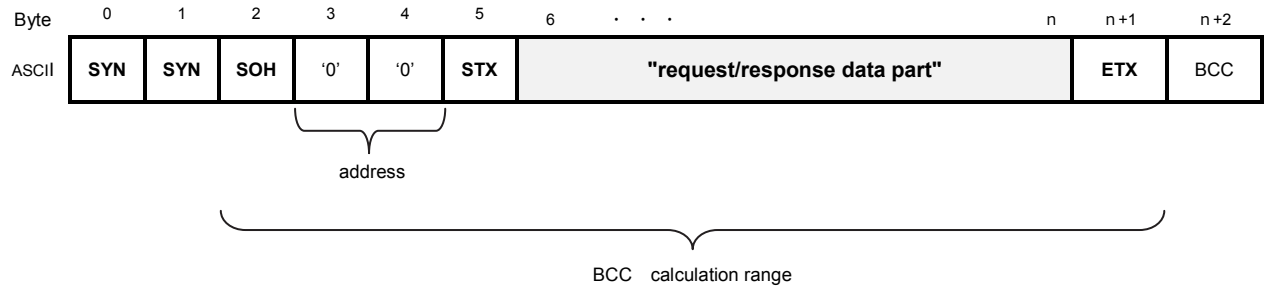

※BCC is the lower 8 bits of the result of the XOR the characters in the range of between SOH ~ ETX on a bit-by-bit basis.

※Byte 3-4 : Address is fixed with '0' '0' (0 x 30, 0 x 30).

## 5.2 ACK/NAK response packet

Response data to a setting request command is as follows of the ACK / NAK.

### 5.2.1 ACK packet output direction) TM2657→ external device

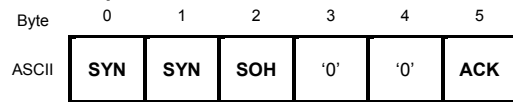

### 5.2.2 NAK packet output direction) TM2657→ external device

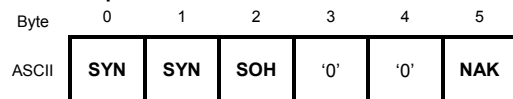

※Byte 3-4 : Address is fixed with '0' '0' (0 x 30, 0 x 30). (No **STX,ETX,BCC**)

---

## 5.3 Blood pressure measurement start (ST) command

For start/stop measurements from the external device, input the basic format (refer to 5.1) containing ST commands. (Doing so, it is likely that the product configuration will regard it as a system medical device.

- 1) ST requirement command (Output direction : external device → TM2657)

Byte	0	1
ASCII	'S'	'T'

- 2) ST response data (output direction : TM2657 → external device)

If the measurement is able to start, the ACK response packet is sent.

If the measurement is not able to start, the NAK response packet is sent.

---

## 5.4 Blood pressure measurement end (SP) command

If you make a start / stop of the measurement from the external device, input the basic format (see 5.1) containing ST command.(In that case, it is likely to be regarded as a medical device in the entire system by the product configuration).

- 1) SP requirement command (output direction : external device → TM2657)

Byte	0	1
ASCII	'S'	'P'

- 2) SP response data (output direction : TM2657 → external device)

If the measurement is able to stop, the ACK response packet is sent.

If the measurement is not able to stop, the NAK response packet is sent.

---

## 5.5 Pressurization setup value (IP) command

Set the pressure (boost) value at the time of blood pressure measurement.

It will return to the set value of the F03 setting once the power supply is shut off.

- 1) IP requirement command (output direction : external device → TM2657)

Byte	0	1	2	3
ASCII	'I'	'P'	ii	

※Stored value

Identifier	Byte	Setting items
ii	2	<Pressurization value set> '00': Automatic applied pressure '16': 160mmHg '18': 180mmHg '20': 200mmHg

- 2) IP response data (output direction : TM2657 → external device)

If the pressurization value is able to set, the ACK response packet is sent.

If the pressurization value is not able to set, the NAK response packet is sent.

## 5.6 Date setting (YS) command

Set the date

1) YS setting requirement command (output direction : external device → TM2657)

Byte	0	1	2	3	4	5	6	7
ASCII	'Y'	'S'	y	y	m	m	d	d

※Stored value

Identifier	Byte	Setting items
yy	2	<setting day>yymmdd yy : To store the year the last two digits. The setting range is from '15' to '50'. mm : To store the value of the month. The setting range is from '01' to '12'. dd : To store the value of the day. The setting range is from '01' to '31'. ※Zero padding ex) '01' : 0x30 0x31
mm	2	
dd	2	

2) YS response data (output direction : TM2657 → external device)

If the date is able to set, the ACK response packet is sent.

If the date value is not able to set, the NAK response packet is sent.

## 5.7 Time setting (DS) command

Time setting of the clock

1) DS setting requirement command (output direction : external device → TM2657)

Byte	0	1	2	3	4	5	6	7
ASCII	'D'	'S'	HH	MM	SS			

※Stored value

Identifier	Byte	Setting items
HH	2	<Setting time>HHMMSS HH: To store the value of the current time. The setting range is from '00' to '23'. MM: To store the value of the current minute. The setting range is from '00' to '59'. SS: To store the value of the current second. The setting range is from '00' to '59'. ※Zero padding ex) '01' : 0x30 0x31
MM	2	
SS	2	

2) DS response data (output direction : TM2657 → external device)

If the time is able to set, the ACK response packet is sent.

If the time value is not able to set, the NAK response packet is sent.

## 5.8 The measurement result request (RB) command

Request the previous measurement data in RB format.

- 1) RB measurement result requirement command (output direction : external device → TM2657)

Byte	0	1
ASCII	'R'	'B'

- 2) RB response data (output direction : TM2657 → external device)

Byte	0	1	2	3	4	5	6	7	8	9	10	11	12	13	14	15
ASCII	'T'	'M'	'2'	'6'	'5'	'5'	RS	yy		mm		dd		HH		MM→
	16	17	18	19	20	21	22	23	24	25	26	27	28	29	30	31
	←MM	RS	'R'	'B'	RS	m	RS	'E'	ee	RS	'S'		sys		RS	
	32	33	34	35	36	37	38	39	40	41	42	43	44	45	46	47
	'M'		map		RS	'D'		dia		RS	'P'		pul		RS	'I'
	48	49	50	51	52	53	54	55								
		ii		RS	'L'		III									RS

※Stored value by the state:

Identifier	Byte	Blood pressure measurement (normal) result	Blood pressure measurement error result	No previous value or Sequence is not in the measurement standby state
yy	2	<Measurement start time>yymmddHHMM yy : To store the year the last two digits. The setting range is from '15' to '50'. mm : To store the value of the month. The setting range is from '01' to '12'. dd : To store the value of the day. The setting range is from '01' to '31'. HH : To store the value of the current time. The setting range is from '00' to '23'. MM : To store the value of the current minute. The setting range is from '00' to '59'. ※Zero padding ex) '01' : 0x30 0x31		Current date and time
mm	2			
dd	2			
HH	2			
MM	2			
m	1	<Mode> 'R': Remote measurement, 'M': Manual measurement		' ' (space)
ee	2	'00' : 0x30 0x30	<Blood pressure measurement error code> ※Refer to the appendix for error code ※Zero padding	' ' (space)
sys	3	<Measurement result> sys(S) : Systolic blood pressure [mmHg] map(M) : Mean arterial blood pressure [mmHg] dia(D) : Diastolic blood pressure [mmHg] pul (P) : Pulse rate bpm ※Zero suppression	<Measurement result error> '000' : 0x30 0x30 0x30	' ' (space)
map	3			' ' (space)
dia	3			' ' (space)
pul	3			' ' (space)
ii	2	<Pressurization setup value> [mmHg/10] Store the value of the pressurization value set by dividing by 10. 160mmHg: '16', 180mmHg: '18', 200mmHg: '20', AUTO: '00'		' ' (space)
III	3	<Maximum pulse amplitude> [mmHg] ※Zero suppression Maximum value : '999'		' ' (space)

## 5.9 The measurement result request with ID (RB) command

Request the previous measurement data in RI format.

- 1) RI measurement result requirement command (output direction : external device → TM2657)

Byte	0	1
ASCII	'R'	'I'

- 2) RI response data (output direction : TM2657 → external device)

Byte	0	1	2	3	4	5	6	7	8	9	10	11	12	13	14	15
ASCII	'T'	'M'	'2'	'6'	'5'	'5'	RS	yy	mm	dd	HH	MM→				
	16	17	18	19	20	21	22	23	24	25	26	27	28	29	30	31
	←MM	RS	'R'	'I'	RS	id→										
	32	33	34	35	36	37	38	39	40	41	42	43	44	45	46	47
	←id					RS	'E'	ee	RS	sys	RS	dia→				
	48	49	50	51	52	53										
	←dia	RS	pul			RS										

※Stored value by the state:

Identifier	Byte	Blood pressure measurement (normal) result	Blood pressure measurement error result	No previous value or Sequence is not in the measurement standby state
yy	2	<Measurement start time >yymmddHHMM yy : To store the year tha last two digits. The setting range is from '15' to '50'. mm : To store the value of the month. The setting range is from '01' to '12'. dd : To store the value of the day. The setting range is from '01' to '31'. HH : To store the value of the current time. The setting range is from '00' to '23'. MM : To store the value of the current minute. The setting range is from '00' to '59'. ※Zero padding ex) '01' : 0x30 0x31		Current date and time
mm	2			
dd	2			
HH	2			
MM	2			
id	16	<Mesurer ID> 16-digit fixed.It is stored in the left-justified. Digits less than 16 digits are filled with SP(0x20). If the ID is not read, the ID is SP(0x20).		
ee	2	'00' : 0x30 0x30	<Blood pressure measurement error code> ※Refer to the appendix for error code ※Zero padding	' '(space)
sys	3	<Measurement result> sys(S) : Systolic blood pressure [mmHg] dia(D) : Diatolic blood pressure [mmHg] pul (P): Pulse rate [bpm] ※Zero suppression	<Measurement result error> '000' : 0x30 0x30 0x30	' '(space)
dia	3			' '(space)
pul	3			' '(space)



## 5.10 The measurement result request with ID (BP) command

Request the previous measurement data in BP format.

- 1) BP measurement result requirement command (output direction : external device → TM2657)

Byte	0	1
ASCII	'B'	'P'

- 2) BP response data (output direction : TM2657 → external device)

Byte	0	1	2	3	4	5	6	7	8	9	10	11	12	13	14	15
ASCII	'B'	'P'	id →													
	16	17	18	19	20	21	22	23	24	25	26	27	28	29	30	31
	← id		yy		mm		dd		HH		MM		sys		dia →	
	32	33	34	35	36	37										
	← dia		pul		NUL											

※Stored value by the state:

Identifier	Byte	Blood pressure measurement (normal) result	Blood pressure measurement error result
id	16	<Mesurer ID> 16-digit fixed. It is stored in the left-justified. Digits less than 16 digits are filled with SP(0x20). If the ID is not read, the ID is SP(0x20).	
yy	2	<Measurement start time >yymmddHHMM yy : To store the year the last two digits. The setting range is from '15' to '50'. mm : To store the value of the month. The setting range is from '01' to '12'. dd : To store the value of the day. The setting range is from '01' to '31'. HH : To store the value of the current time. The setting range is from '00' to '23'. MM : To store the value of the current minute. The setting range is from '00' to '59'. ※Zero padding Ex) '01' : 0x30 0x31	
mm	2		
dd	2		
HH	2		
MM	2		
sys	3	<Measurement result> sys : Systolic blood pressure [mmHg] dia : Diastolic blood pressure [mmHg] pul : Pulse rate [bpm]	<Measurement result error> '000' : 0x30 0x30 0x30
dia	3	※Zero suppression ex) '90' : 0x20 0x39 0x30	
pul	3		

## 5.11 Blood pressure result output (RA)

Request the previous measurement data in BA format.

1) RA measurement result requirement command (output direction : external device → TM2657)

Byte	0	1
ASCII	'R'	'A'

2) RA response data (output direction : TM2657 → external device)

Byte	0	1	2	3	4	5	6	7	8	9	10	11	12	13	14	15
ASCII	'T'	'M'	'Z'	'6'	'5'	model	<b>RS</b>	yy		mm		dd		HH		MM →
	16	17	18	19	20	21	22	23	24	25	26	27	28	29	30	31
	←MM	<b>RS</b>	'R'	'A'	<b>RS</b>	md	<b>RS</b>	'E'	ee	<b>RS</b>	'S'	sys				<b>RS</b>
	32	33	34	35	36	37	38	39	40	41	42	43	44	45	46	47
	'M'	map			<b>RS</b>	'D'	dia			<b>RS</b>	'P'	pul			<b>RS</b>	'I'
	48	49	50	51	52	53	54	55	56	57	58	59	60	61	62	63
	li	<b>RS</b>	'L'	lll			<b>RS</b>	'p'	mprs			<b>RS</b>	'i'	ihb		
	64	65	66	67	68	69	70	71	72	73	74	75	76	77	78	79
	<b>RS</b>	'm'	motn	<b>RS</b>	'r'	rem	<b>RS</b>	't'	mt			<b>RS</b>	'c'	dir	<b>RS</b>	'l'
	80	81	82	83	84	85	86	87	88	89	90	91	92	93	94	95
	Cuff	<b>RS</b>	'd'	id→												
	96	97	98	99	100	101	102	103	104	105	106	107	108	109	110	111
	←id			<b>RS</b>	'h'	hei					<b>RS</b>	's'	sit→			
	112	113	114	115	116	117	118	119	120	121	122	123	124	125	126	127
	←sit	<b>RS</b>	'w'	wei							<b>RS</b>	'f'	tr→			
	128	129	130	131	132	133	134	135	136	137	138	139	140	141	142	143
	←tr	<b>RS</b>	'e'	pt							<b>RS</b>	'b'	bmi→			
	144	145														
	←bmi	<b>RS</b>														

※Stored value by the state:

Identifier	Byte	Blood pressure measurement (normal) result	Blood pressure measurement error result	No previous value or Sequence is not in the measurement standby state
model	1	<Model identify> TM2656:'6', TM2657:'7'		
yy	2	<Measurement start time >yymmddHHMM yy : To store the year the last two digits. The setting range is from '15' to '50'. mm : To store the value of the month. The setting range is from '01' to '12'. dd : To store the value of the day. The setting range is from '01' to '31'. HH : To store the value of the current time. The setting range is from '00' to '23'. MM : To store the value of the current minute. The setting range is from '00' to '59'. ※Zero padding Ex) '01' : 0x30 0x31		<current date and time>
mm	2			
dd	2			
HH	2			
MM	2			
md	1	<Mode> 'R': remote measurement, 'M': manual measurement		' '(1 space)
ee	2	'00' : 0x30 0x30	<Blood pressure measurement error code> ※Zero padding	' '(2 space)
sys(S)	3	<Measurement result> sys(S) : Systolic blood pressure [mmHg] map(M) : Mean arterial blood pressure [mmHg] dia(D) : Diastolic blood pressure [mmHg] pul (P) : Pulse rate [bpm] ※Zero suppression		' '(3 space)
map(M)	3			' '(3 space)
dia(D)	3			' '(3 space)
pul(P)	3			' '(3 space)
ii(I)	2	<Pressurization value set> [mmHg/10] Store the value of the pressurization value set by dividing by 10. 160mmHg:'16', 180mmHg : '18', 200mmHg:'20', AUTO : '00'		' '(2 space)
ll(L)	3	<Maximum pulse range> [mmHg] ※Zero suppression Maximum value : '999'		' '(3 space)
mprs(p)	3	<Maximum pressure> (200msec main detect)[mmHg] ※Zero suppression		' '(3 space)
ihb(i)	2	<Irregula pulse number> [times] '0':no '1'~'15' detect times ※Zero suppression	' '(2 space)	
motn(m)	1	<Body motion detect> '0':No '1':Yes	' '(1 space)	
rems(r)	1	<Number of re-measure times> [times]		' '(1 space)
mt(t)	3	<Blood pressure measurement start time> [sec] Zero suppression		' '(3 space)
dir(c)	1	<Measurement start switch conditions> L:left R:right N:no distinction		' '(1 space)
cuff(l)	2	<Cuff information> [cm] ※ Currently not measured, space fixed. 0x20 0x20		' '(2 space)
id(d)	16	<Mesurer ID> 16 digits fixed. Store in the left-justified. Digits less than 6 digits fill in the SP (0x20). If ID is not been read,it fill in the SP(0x20).		' '(16 space)
hei(h)	5	< Height value >'xxx.x'[cm] ※Zero suppression		' '(5 space)
sit(s)	5	< Sitting height value >'xxx.x'[cm] ※Zero suppression		' '(5 space)
wei(w)	6	< Weight value >'xxx.x ' or 'xxx.xx'[kg] ※ If the decimal point one digit, second digit stores SP(0x20).		' '(6 space)
tr(f)	6	< Tare value >'xxx.x ' or 'xxx.xx'[kg] ※ If the decimal point one digit, second digit stores SP(0x20).		' '(6 space)
pt(e)	6	<Preset tare value> 'xxx.x ' or 'xxx.xx'[kg] ※ If the decimal point one digit, second digit stores SP(0x20).		' '(6 space)
bmi(b)	5	<BMI> 'xxx.x' ※Zero suppression		' '(5 space)

※ In the case of TM2657, dir (c) measurement start switch condition is always 'N'.

## 5.12 Pulse wave data request (RP) command

Request the previous measurement data in RP format.

- 1) RP pulse wave data request command (output direction : external device → TM2657)

Byte	0	1
ASCII	'R'	'P'

- 2) RP response data (output direction: TM2657 → external device)

Byte	0	1	2	3	4	5	6	7	8	9	10	11	12	13	14	15
ASCII	'T'	'M'	'2'	'6'	'5'	'5'	RS	yy	mm	dd	HH	MM	→			
	16	17	18	19	20	21	22	23	24							
	←	RS	'R'	'P'	RS	'N'	nnn									

※Stored value by the state:

Identifier	Byte	Blood pressure measurement (normal) result	Blood pressure measurement error result	No previous value or Sequence is not in the measurement standby state
yy	2	<Measurement start time >yyymmddHHMM yy : To store the year the last two digits. The setting range is from '15' to '50'. mm : To store the value of the month. The setting range is from '01' to '12'. dd : To store the value of the day. The setting range is from '01' to '31'. HH : To store the value of the current time. The setting range is from '00' to '23'. MM : To store the value of the current minute. The setting range is from '00' to '59'. ※Zero padding ex) '01' : 0x30 0x31		<current date and time>
mm	2			
dd	2			
HH	2			
MM	2			
nnn	3	Store the pulse number. Maximum data number is 160. (TM2655 is 100). If it is less than three digits to the right-justified. To zero suppression in the blank (0x20).		'(space)' '(space)' '0'

- 2) RP response data (A : nnn = 1~160 (TM2657 → external device)

If there is a pulse number, the next packet data is followed by RP response data (1) (separate packet).

Store the pulse data of the number specified in the nnn.

Byte	0	1	2	3	4	5	6	7	8	9	10	11	12	13	14	15
ASCII	RS	prs_[0]	','	amp_[0]	RS	prs_[1]	','	amp_[1]								
	16	17	18	19	20	21	22	23	...	...	...	...	...	...	...	...
	RS	prs_[2]	','	amp_[2]	RS	prs_[n-2]	','	amp_[n-2]								
	...	...	...	...	...	...	...	...								
	RS	prs_[n-1]	','	amp_[n-1]												

prs: Store the pressure value. [0]~[n-1] The smaller side of the index is the high-pressure side. (Zero suppression)

amp: Store the pulse pressure value. [0]~[n-1] The smaller side of the index is the high-pressure side. (Zero suppression)

- 3) Response data (B : nnn = 0 (TM2657 → external device)

Should there be no pulse number, previous value or be non-idle (not in the measurement standby state), the next packet data will follow packet data 1.

(separate packet).

Byte	0	1	2	3	4	5	6
ASCII	'N'	'O'	''	'D'	'A'	'T'	'A'

## 5.13 Request the previous measurement data in RS format.

1) RS command: Blood pressure data transmission request command (Output direction : External device → TM2657)

Byte	0	1
ASCII	'R'	'S'

2) RS response data (output direction:TM2657→external device).

Byte	0	1	2	3	4	5	6	7	8	9	10	11	12	13	14	15
ASCII	'T'	'M'	'2'	'6'	'5'	'5'	RS	yy		mm		dd		HH		MM→
	16	17	18	19	20	21	22	23	24							
	←MM	RS	'I'	ii		RS	st		RS							

※Stored value:

Identifier	Byte	Setting items
yy	2	<date and time at the moment>ymmddHHMM yy : To store the year tha last two digits. The setting range is from '15' to '50'. mm : To store the value of the month. The setting range is from '01' to '12'. dd : To store the value of the day. The setting range is from '01' to '31'. HH : To store the value of the current time. The setting range is from '00' to '23'. MM : To store the value of the current minute. The setting range is from '00' to '59'. ※Zero padding Ex) '01' : 0x30 0x31
mm	2	
dd	2	
HH	2	
MM	2	
ii	2	Store the pressurization value setting <mmHg/10> '00' : Automatic applied pressure '16' : 160mmHg '18' : 180mmHg '20' : 200mmHg
st	2	Store the current state. 'RE' : Standby for measurement 'BR' : Performing manual measurement (when the start switch is pressed and blood pressure measurement is performed) 'BM' : Performing manual measurement (when the start switch is pressed and blood pressure measurement is performed) 'BS' : Busy state in communication

## 5.14 Measurement number request (CT) command

Request the total number of measurements value(counter)

1) CT measurement number request command (Output direction : external device → TM2657)

Byte	0	1
ASCII	'C'	'T'

2) CT response data (Output direction : TM2657 → external device)

Byte	0	1	2	3	4	5	6	7	8	9	10	11	12	13	14	15
ASCII	'T'	'M'	'2'	'6'	'5'	'5'	RS	yy		mm		dd		HH		MM→
	16	17	18	19	20	21	22	23	24							
	←MM	RS	'C'	'T'	cnt				RS							

※Stored value:

Identifier	Byte	Setting items
yy	2	<Current date>yymmddHHMM yy : To store the year tha last two digits. The setting range is from '15' to '50'. mm : To store the value of the month. The setting range is from '01' to '12'. dd : To store the value of the day. The setting range is from '01' to '31'. HH : To store the value of the current time. The setting range is from '00' to '23'. MM : To store the value of the current minute. The setting range is from '00' to '59'. ※Zero padding Ex) '01' : 0x30 0x31
mm	2	
dd	2	
HH	2	
MM	2	
cnt	16	Store the current number of times the total measurement.(zero padding)

## 5.15 ID request (ID) command

Request being loaded ID.

1) ID requirement command (output direction: external device → TM2657)

Byte	0	1
ASCII	'I'	'D'

2) ID response data (output direction : TM2657 → external device)

Byte	0	1	2	3	4	5	6	7	8	9	10	11	12	13	14	15
ASCII	'T'	'M'	'2'	'6'	'5'	'5'	RS	yy	mm	dd	HH	MM→				
	16	17	18	19	20	21	22	23	24	25	26	27	28	29	30	31
	←MM	RS	'I'	'D'	id→											
	32	33	34	35	36											
	←id				NULL											

※Stored value:

Identifier	Byte	Setting items
yy	2	<Current day time >yymmddHHMM yy : To store the year the last two digits. The setting range is from '15' to '50'. mm : To store the value of the month. The setting range is from '01' to '12'. dd : To store the value of the day. The setting range is from '01' to '31'. HH : To store the value of the current time. The setting range is from '00' to '23'. MM : To store the value of the current minute. The setting range is from '00' to '59'. ※Zero padding Ex) '01' : 0x30 0x31
mm	2	
dd	2	
HH	2	
MM	2	
id	16	The numeric value aligns to the left, and others replace a blank space (0x20).

## 5.16 BPM serial number request (BS) command

Request the serial number of built-in BPM (blood pressure measurement module TM-2915).

1) BS requirement command (output direction : external device → TM2657)

Byte	0	1
ASCII	'B'	'S'

2) BS response data (outoput direction : TM2657 → external device)

Byte	0	1	2	3	4	5	6	7	8	9	10	11	12	13	14	15
ASCII	'T'	'M'	'2'	'6'	'5'	'7'	RS	yy	mm	dd	HH	MM→				
	16	17	18	19	20	21	22	23	24	25	26	27	28	29	30	31
	←MM	RS	'B'	'S'	bpmnsn→											
	32	33	34	35	36											
	←bpmnsn				RS											

※Stored value:

Identifier	Byte	Setting items
yy	2	<current day time>yymmddHHMM yy : To store the year tha last two digits. The setting range is from '15' to '50'. mm : To store the value of the month. The setting range is from '01' to '12'. dd : To store the value of the day. The setting range is from '01' to '31'. HH : To store the value of the current time. The setting range is from '00' to '23'. MM : To store the value of the current minute. The setting range is from '00' to '59'. ※Zero padding Ex) '01' : 0x30 0x31
mm	2	
dd	2	
HH	2	
MM	2	
bpmnsn	16	BPM serial number that is stored in the EEPROM of TM-2657. (The numeric value of ID aligns to the left, and others replace a blank space (0x20).) ※If this unit number is not registered (L01 not implemented), all the digits to fill in the SP(0x20).



# 6 Commnunication format (other company measurement results automatic output)

The blood pressure result automatic output data outputs to an external device from the output terminal  only once immediately after the measurement. It can be selected from Ux, RVX or RVY using the F20 external output input setting.

## 6.1 Measurement result automatic output (Ux) format

If the blood pressure result output format setting F20 is set to "4" UX compatible, the UX (blood pressure results automatic output data) outputs to an external device  without request from the outside only once immediately after the measurement with RA format.

Byte	0	1	2	3	4	5	6	7	8	9	10	11	12	13	14	15
ASCII	<b>STX</b>	0x27	yy	0xF2	mm	0xF3	dd	0xF4	<b>CR</b>	ap	<b>SP</b>	HH→				
	16	17	18	19	20	21	22	23	24	25	26	27	28	29	30	31
	←HH	0xF5	MM	0xF6	<b>CR</b>	'S'	'B'	'P'	'='	sys		'm'	'm'	'H'		
	32	33	34	35	36	37	38	39	40	41	42	43	44	45	46	47
	'g'	<b>CR</b>	'D'	'B'	'P'	'='	dia		'm'	'm'	'H'	'g'	<b>CR</b>	'P'	'L'	
	48	49	50	51	52	53	54	55	56	57						
	'S'	'='	pul		'B'	'P'	'M'	<b>CR</b>	<b>ETX</b>							

※Stored value by the state:

Identifier	Byte	Blood pressure measurement (normal) result	Blood pressure measurement error result
yy	2	<Measurement start time >yymmddHHMM yy : To store the year tha last two digits. The setting range is from '15' to '50'. mm : To store the value of the month. The setting range is from '01' to '12'. dd : To store the value of the day. The setting range is from '01' to '31'. ap : Store with 'AM' or 'PM' HH : To store the value of the current time. The setting range is from '00' to '23'. MM : To store the value of the current minute. The setting range is from '00' to '59'.  ※Zero padding Ex) '01' : 0x30 0x31	
mm	2		
dd	2		
ap	2		
HH	2		
MM	2		
sys	3	<Measurement result> sys : Maximum blood pressure [mmHg] dia : Minimum blood pressure [mmHg] pul: Pulse rate [bpm] ※Zero padding Ex) '090' : 0x30 0x39 0x30	<Measurement result error> '000' : 0x30 0x30 0x30
dia	3		
pul	3		

※ TM-2657 sends out in 3 continuous packet by one measurement result output (58bytes \* 3 = 174bytes).

## 6.2 Measurement result automatic output (RVX compatible) format

If the blood pressure results output format setting F20 is set to "5" RVX, the blood pressure results automatic output data outputs to an external device from the output terminal  only once immediately format after the measurement with next RVX format.

Byte	0	1	2	3	4	5	6	7	8	9	10	11	12	13	14	15
ASCII	STX	'I'	'D'	'9'	'9'	'9'	'9'	'9'	'9'	'9'	'9'	'B'	yy	'/'	mm→	
	16	17	18	19	20	21	22	23	24	25	26	27	28	29	30	31
	←mm	'/'	dd	'/'	HH	':'	MM	SP		sys		SP		dia→		
	32	33	34	35	36	37	38	39								
	←dia	SP		pul		SP	ETX									

※Stored value by the state:

Identifier	Byte	Blood pressure measurement (normal) result	Blood pressure measurement error result
yy	2	<Measurement start time >yymmddHHMM yy : To store the year the last two digits. The setting range is from '15' to '50'. mm : To store the value of the month. The setting range is from '01' to '12'. dd : To store the value of the day. The setting range is from '01' to '31'. HH : To store the value of the current time. The setting range is from '00' to '23'. MM : To store the value of the current minute. The setting range is from '00' to '59'. ※Zero padding Ex) '01' : 0x30 0x31	
mm	2		
dd	2		
HH	2		
MM	2		
sys	3	<Measurement result> sys : Systolic blood pressure [mmHg] dia : Diastolic blood pressure [mmHg] pul: Pulse rate [bpm] ※Zero padding Ex) '090' : 0x30 0x39 0x30	<Measurement result error> ' ' : 0x20 0x20 0x20
dia	3		
pul	3		

※As of 2015 June 1, the feature of "RVX format output +ID input" is not realized in the TM2657 specification.

## 6.3 Measurement result automatic output (RVY compatible) format

If the blood pressure results output format setting F20 is set to "7" RVY, the blood pressure results automatic output data outputs to an external device from the output terminal  only once immediately format after the measurement with next RVY format.

Byte	0	1	2	3	4	5	6	7	8	9	10	11	12	13	14	15
ASCII	'b'	'p'	','	id →												
	16	17	18	19	20	21	22	23	24	25	26	27	28	29	30	31
	← id							','	yyyy				','	mm	','	
	32	33	34	35	36	37	38	39	40	41	42	43	44	45	46	47
	dd	','	HH	','	MM	','	sys			','	map					
	48	49	50	51	52	53	54	55	56	57	58					
	','	dia			','	pul			','	i	0x0D					

※Stored value by the state:

Identifier	Byte	Blood pressure measurement (normal) result	Blood pressure measurement error result
id	20	<ID> If digit is less than 16 digits(TM2657 is MAX 16 digits), it is a left-justified , surplus digits is filled with the space(0x20). If there is no ID, it is filled with all digits "9"('999999999999999999').	No output
yyyy	4	<Measurement start time >yyyymmddHHMM yyyy : To store the year tha last four digits. The setting range is from '2015' to '2050'.	
mm	2	mm : To store the value of the month. The setting range is from '01' to '12'.	
dd	2	dd : To store the value of the day. The setting range is from '01' to '31'.	
HH	2	HH : To store the value of the current time. The setting range is from '00' to '23'.	
MM	2	MM : To store the value of the current minute. The setting range is from '00' to '59'.	
sys	3	※Zero padding Ex) '01' : 0x30 0x31	
map	3	<Measurement result> sys : Systolic blood pressure [mmHg] map: Mean arterial blood pressure [mmHg]	
dia	3	dia : Diatolic blood pressure [mmHg]	
pul	3	pul: Pulse rate [bpm] ※Zero padding Ex) '090' : 0x30 0x39 0x30	
i	1	<Illegal signal> Store the IHB of the TM2657. '0' : TM2657 IHB Count value 0 '1' : TM2657 IHB Count value 1 '2' : TM2657 IHB Count value 2 '3' : TM2657 IHB Count value 3	

※As of 2015 June 1, the feature of "RVY format output +ID input" is not realized in the TM2657 specification.

# 7 Bluetooth (SPP) connection

## 7.1 System example

When the external input-output unit "RS+BT-SPP (TM2657-06)" is installed, TM-2657 connects to a paired device (below Bluetooth HOST) using "Bluetooth SPP wireless. Bluetooth HOST is limited to communication equipment supporting a serial port profile (SPP), such as a PC built-in device, PC+Bluetooth dongle, smart phone, tablet, or Bluetooth + microcomputer board.

Before connected with the Bluetooth SPP. Bluetooth HOST and TM-2657 must be paired.

\*Bluetooth SPP (Serial Port Profile )

1 ) External output-input unit RS+BT-SPP (TM2657-06) connection example

○ID reader, PC (Bluetooth/SPP) connecting

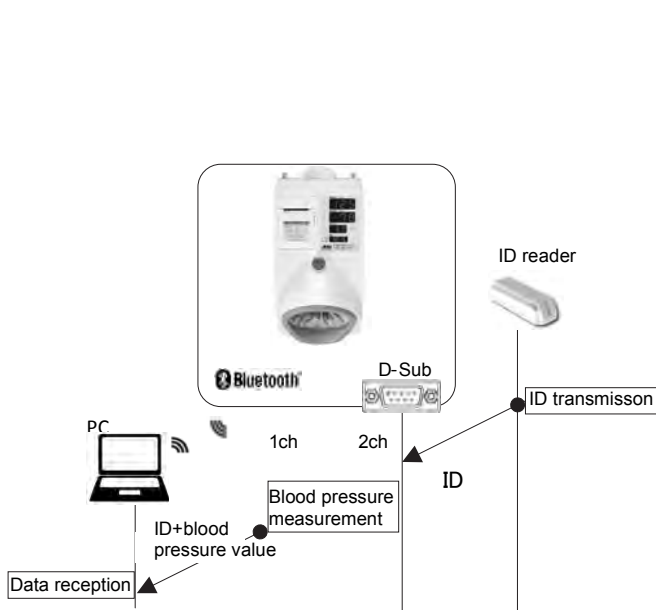

\* In the case of No ID reader connection, ID information is output in the blank.

【Machine setting】

Connecting device **F20:[ 3 ]** ch1: Measurement result output  
 ch2:ID reader  
 Measurement result output setting ---

【ch1 communication setting】

Baud rate **F21** (1200 / 2400 / 4800 / 9600 )  
 Start bit 1 (fixed)  
 Data length 8 (fixed)  
 Parity None (fixed)  
 Stop bit **F23** (1 / 2)

【ch2 communication setting】

Baud rate **F22** (1200 / 2400 / 4800 / 9600 )  
 Start bit 1 (fixed)  
 Data length 8 (fixed)  
 Parity None (fixed)  
 Stop bit **F24** (1 / 2)

---

## 7.2 Pairing method

In order to communicate with the Bluetooth HOST, TM-2657 must be paired with the device.

Once paired, the blood pressure measurement data is automatically sent to the connected device every time a measurement is made.

For pairing of TM2657-06 and Bluetooth HOST, complete the following steps.

Pairing information is maintained even after the OFF the power of the TM-2657.

In addition, please refer to the instructions of the Bluetooth HOST.

If the pairing wizard has been prepared, please use there.

- 1) According to the instructions of the Bluetooth HOST, ready for pairing.

When paired with a TM2657-06, please go in as close as possible to the Bluetooth HOST.

- 2) Turn on the power of the automatic blood pressure monitor connected to TM-2657-06. Once that is done, Bluetooth HOST will be able to locate TM-2657.

- 3) According to the instructions of the Bluetooth HOST, search for TM-2657, select, do the pairing.

After searched, "TM2657-SPP-XXXX" is displayed. "XXXX" is the last four digits of the Bluetooth address.

Please enter the "1234" if the PIN code is required in the Bluetooth HOST side.

- 4) When pairing is successful on the Bluetooth HOST side, pairing is complete.

If it fails, try again from (1) and then turn on TM-2657 power.



If TM-2657 shows F20=OFF, pairing cannot be completed.

## 7.3 External input and output setting (F20/F21/F22/F23/F24)

Bluetooth SPP communication settings set by the Bluetooth HOST side as virtual COM (VCOM) setting, TM-2657 is in the same procedure as the CH1 of TM2657-03, it can be set in the function settings below.

By setting the external I / O unit and function setting F20, it can be changed to suit the transmission and reception functions of CH1 / CH2.

In addition, the baud rate and stop bit if CH1 / CH2 is can be changed by the setting of the F21 / F22. F23 / F24.

Option 1 (TM2657-06)		CH1 					CH2 				
F20	Description	Function	Baudrate	Databit	Parity	Stopbit	Function	Baudrate	Databit	Parity	Stopbit
OFF	No external output	No external output	No communication				No external output	No communication			
1	CH1:measurement result output CH2:measurement result output	measurement result output	F21	8	None	F23	measurement result output	F22	8	None	F24
2	CH1:A&D height wight scale CH2:measurement result output	A&D height wight scale	* 2400	7	Even	F23	measurement result output	F22	8	None	F24
3	CH1:measurement result output CH2:ID reader	measurement result output	F21	8	None	F23	ID reader	F22	8	None	F24
4	CH1:measurement result output CH2:Ux compatible	measurement result output	F21	8	None	F23	Ux interchangeable	F22	8	Even	* 2
5	CH1:measurement result output CH2:RVX compatible	measurement result output	F21	8	None	F23	RVX interchangeable	* 2400	7	Even	* 1
6	CH1:measurement result output CH2:A&D height wight scale	measurement result output	F21	8	None	F23	A&D height wight scale	* 2400	7	Even	F24
7	CH1:measurement result output CH2:RVY compatible	measurement result output	F21	8	None	F23	RVY interchangeable	* 2400	8	Even	* 1

- \* Item is fixed, regardless of the setting of the F22 or F24.
- Databit and Parity are fixed, regardless of the setting of the F20 (It cannot be selected.)
- The setting variation (baud rate) of F21 and F22 is one of the "1200, 2400, 4800, 9600".
- The setting variation (stop bit) of F23 and F24 is the "1" or "2".
- Measurement result output format can be selected in the next F25.
- In the case of " F20 = 2", height and wight scale data of Bluetooth connection (CH1) is always ready to receive.
- To set the time of the F16(height and weight value printing setting) = 2(Integrated print mode), it hold only 1 latest data when receiving a plurality of times of height and wight value during the measurement.

## 7.4 Measurement result output setting (F25)

measurement result output setting		Automatic output format immediatly after measurement	PC command (STD) response Yes / No
F25	Description		
1	RB (no ID, immediatly after measurement) + STD	RB (no ID, immediatly after measurement)	Yes
2	RI (with ID, immediatly after measurement) + STD	RI (with ID, immediatly after measurement)	Yes
3	BP (with ID, immediatly after measurement)	BP (with ID, immediatly after measurement)	No
4	STD (command response)	No automatic output	Yes
5	RA (with ID, immediatly after measurement) + STD	RA (with ID, immediatly after measurement)	Yes

Concerning the each communication format (RB/RI/BP/RA/STD), please refer to "3 communication format (measurement result automatic output" or "4 communication format(STD command) .

## 7.5 Bluetooth authentication setting

TM2657-06 is possible to change the authentication settings at the time of pairing by the following procedure.

By the conditions of the Bluetooth HOST side, please change as needed.

1. Turn ON the [Power] button while holding down the [▲] button on the back of the sphygmomameter.
2. By pressing the [▲] button or [Select] button to fit the time display unit to [L62], then press the [Start / Stop] switch.
3. Since the authentication settings in diastolic blood pressure display unit (default "2" ) is displayed, change the setting in the [▲] button, press the [Start / Stop].
4. If "End" appears to the Lowest blood pressure display unit, the setting is completed.

Lowest blood pressure display	Authentication Settings	Initial setting
0	Open mode. Communicate without encryption (open mode) the data. This mode is useful for legacy devices that do not require security. Authentication is done by a four-digit PIN code. The previous Use in the previous device than Bluetooth2.1.	2
1	SSP Keyboard I/O mode. Display a six-digit authentication code and confirm the match. However, code validation is not performed on this machine, it always returns OK. It is possible to enter unnecessary authentication completion, although verification procedure of authentication code in the authentication device.	
2	SSP[Just Works]mode. Bluetooth2.1+EDR or more of the version, omit the PIN code entered in the SSP (Secure Simple Pairing), automatically in the authentication is completed.	
4	PIN code mode. Mode to authenticate by entering a four-digit PIN code. Use in the previous device than Bluetooth2.1.	



## 8 Bluetooth (Continua) connection

When the external I/O unit RS+BT-C(TM2657-05) is installed to TM-2657, TM-2657 connects to the personal computer and

\*Bluetooth HDP as a health device data corresponding to the continua standard.

Before connecting with Bluetooth, the personal computer and the TM-2657 must be the pairing setting.

\*Bluetooth HDP (Health Device Profile)

1) External output-input unit RS+BT-C (TM2657-05)connecting example

○ID reader, PC (Bluetooth/Continua) connecting

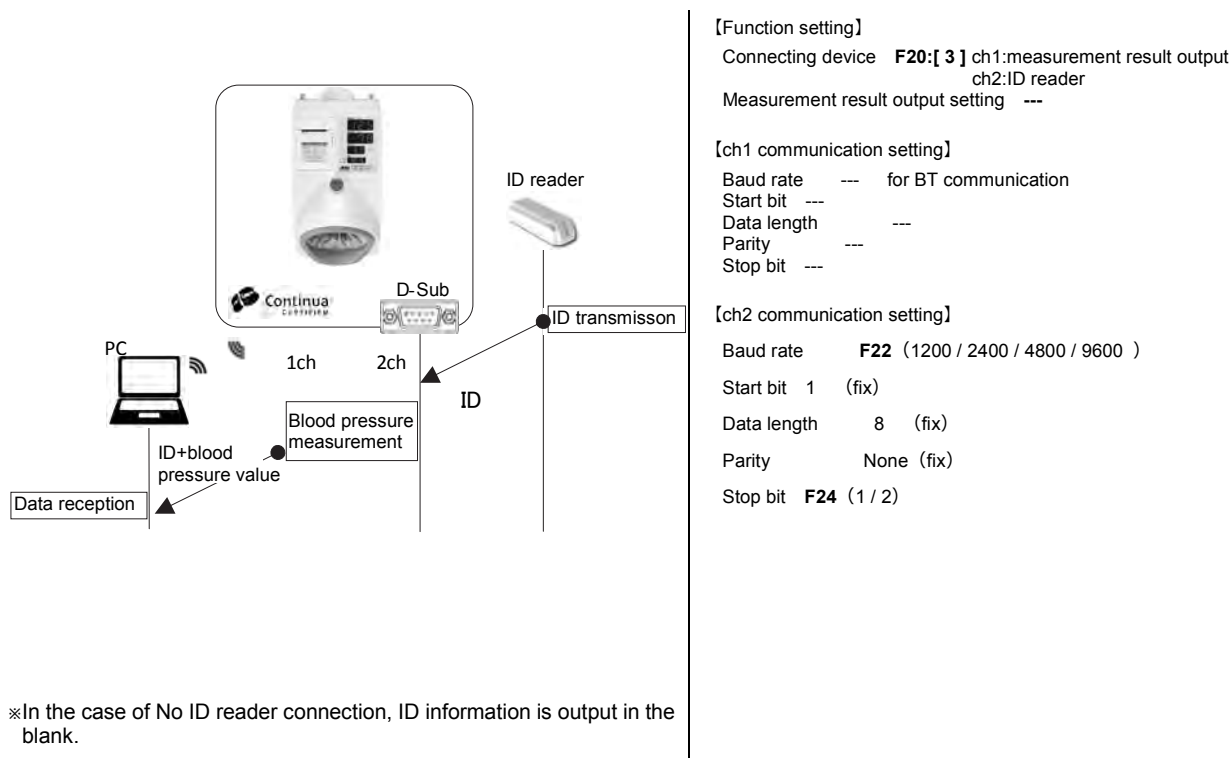

※ Please obtain the technical material from the following URL.

• A&D Bluetooth SDK : Japanese

[https://www.aandd-ps.com/inquiry/estimation\\_support](https://www.aandd-ps.com/inquiry/estimation_support)

• Software development kit for designing communication-enabled healthcare products (SDK) :

<http://www.wellnessconnected.jp/english/sdk/>

• Continua guideline :

<http://www.continua.jp/product.html>

---

## 8.1 Pairing

In order to communicate with Bluetooth HDP, TM-2657 needs to be paired with the personal computer or the like for reception.

Once carried out the pairing, each time to measure the blood pressure measurement, automatically send the blood pressure measurement data to the connected device that pairing.

Pairing of the TM2657-05 and the personal computer for the reception, complete the following steps.

- 1) Place the personal computer or the like for the reception in the pairing state.
- 2) While holding down the TM-2657[Select] button of that attach the TM2657-05, turn on the power of TM-2657.  
Then, since "do" is displayed in the systolic blood pressure display unit or "PAr" is displayed in the diastolic blood pressure display unit, please press the [start / stop] button.

After TM-2657 turn the power ON, TM-2657 can be found by the personal computer or the like.

- 3) According to the instructions of the pairing of the personal computer or the like for receiving, search the TM-2657, selection, do the pairing.

When the search, it will be displayed as "TM2657PBT-Ci XXXXXX". "XXXXXX" is the last six digits of the Bluetooth address.

Please enter the "123456" if the PIN code is required.

- 4) When the pairing is successful in the personal computer for receiving, it is displayed as "End", then the pairing is complete.

Pairing information is maintained even after the OFF the power of the TM-2657.

※It cannot be paired in the case of F20=OFF of TM-2657, TM-2657 can not be paired.

Please set except for F20=OFF.

---

## 8.2 Measurement data transmission

Each time blood pressure is measured, the blood pressure measurement data is automatically sent to the paired device.

If the measurement data cannot be transmitted, up to 200 data will be temporarily stored in the TM2657-05 memory along with the time of measurement.

Should the data exceed 200, data will be erased from the oldest.

Stored data will be sent when a receiving device is connected after the next measurement.

Upon reception confirmation, data will be erased automatically.

Temporary storage capacity can be changed by the receiving equipment.

---

## 8.3 Bluetooth utility mode

TM2657 can be set on the Bluetooth HDP using the Bluetooth utility mode. When performing various settings when not subjected to blood pressure measurement, change the setting in the TM2657 rear panel switch to the following.

ⓄTo ON on the power while holding down the [Select] button.

Ⓞ"Do" is displayed in systolic pressure display unit, and "PAr" is displayed in diastolic blood pressure display unit. Then it enters the Bluetooth utility mode.

ⓄEach press of the [Select] switch, systolic / diastolic blood pressure display section will appear in the order in each mode.

Function	Un-pairing	Data clear	Pairing
Systolic blood pressure display LED	"Un"	"Clr"	"do"
Diastolic blood pressure display LED	"Par"	" d At"	"Par"

- Un-pairing : This is used to cancel the pairing of the personal computer or the like for reception.
- Data clear : Full automatic blood pressure monitors will be able to erase the data that is temporarily stored.
- Pairing : As mentioned earlier of "8.1 pairing", it is used when connecting with the personal computer or the like for the reception.

ⓄIn each item, it is possible to run the [Start / Stop] button at the time of each corresponding display.

---

## 8.4 Time synchronaization

For wireless connection with Bluetooth HDP, depending on the time or day setting request from the personal computer or for the reception, the time of the TM-2657 body and TM2657-05 will update at the time the data is received from the personal computer.

In addition, about 2 minutes after power to TM-2657 or at the time of the first start of measurement, it updates the time of the TM-2657 body at the time the data reaches TM2657-05.

If the time is changed in the time setting operation of the TM-2657 body, it will update the time data of TM2657-05 as well.

With a wireless Bluetooth HDP connection, the updated time data of TM2657-05 will be sent to the personal computer with the measurement results.

## 8.5 External input-output setting (F22/F24)

Bluetooth HDP communication settings set by the Bluetooth HOST side as virtual COM (VCOM) setting, TM-2657 is in the same procedure as the CH1 of TM2657-03, it can be set in the function settings below.

By setting the external I / O unit and function setting F20, it can be changed to suit the transmission and reception functions of CH1 / CH2.

In addition, the baud rate and stop bit if CH1 / CH2 is can be changed by the setting of the F21 / F22. F23 / F24.

Option 5 (TM2657-05)		CH1				CH2 					
F20	Description	Function	Baudrate	Databit	Parity	Stopbit	Function	Baudrate	Databit	Parity	Stopbit
OFF	No external output		Bluetooth	no control of the module			No external output	Not communicate			
1	CH1:Measurement result output CH2: Measurement result output	Bluetooth	Regardless of the F20 setting, control the BT module.(9600, 8, N, 1)				Measurement result output	F22	8	None	F24
2	CH1:A&D Height scales CH2: Measurement result output						Measurement result output	F22	8	None	F24
3	CH1: Measurement result output CH2:ID reader						ID reader	F22	8	None	F24
4	CH1: Measurement result output CH2:Ux compatible						Ux interchangeable	F22	8	Even	* 2
5	CH1: Measurement result output CH2:RVX compatible						RVX interchangeable	* 2400	7	Even	* 1
6	CH1: Measurement result output CH2:A&D height weight scale						A&D height scales	* 2400	7	Even	F24
7	CH1: Measurement result output CH2:RVY compatible						RVY interchangeable	* 2400	8	Even	* 1

- \* Item is fixed, regardless of the setting of the F22 or F24.
- Databit and Parity are fixed, regardless of the setting of the F20 (It cannot be selected.)
- The setting variation (baud rate) of F22 is one of the "1200, 2400, 4800, 9600".
- The setting variation (stop bit) of F24 is the "1" or "2".
- Measurement result output format can be selected in the next F25.
- In case of connecting TM2656-05,CH1 controls the Bluetooth module (9600, 8, N,1) regardless of the setting of F20.
- (However,if F20 is set to OFF, it does not control the BT module.)
-

---





## 8.6 Measurement result output setting (F31)

Measurement result output setting		Bluetooth connecting timing
F31	Description	
1	Connection at the end of measurement	After the connection of the measurement, TM-2657 is connected to a host device, start the Bluetooth communication.
2	Connection at the start of measurement	At the start of the measurement, TM-2657 is connected to a host device, start the Bluetooth communication.

# 9 ID input

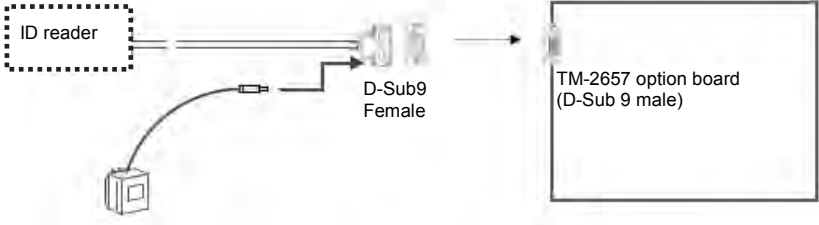
By entering the ID information from the external (ID reader) during the measurement standby, TM-2657 prints the measurement result and ID information, and output an external output.

1) The ID reader example that can be connected to the D-Sub 9pin male terminal of the TM-2657 is shown below.

Connection	NFC Leader terminal	Barcode touch scanner	Magnetic card Leader terminal
Terminal example Specification			
Interface	RS-232C interface-compliant		
Power supply	Supply from AC adapter 		
Reading media example	NFC card (Felica, MIFARE)	CODE39, CODE128, JAN/EAN, NW7, UPC etc	JIS- II CODE
ID leader terminal example	 UFT-N103S (Felica)	 1000R-S09	 PDC-816RL (JIS II)

2) ID information input format

ID number of digits (Max 16 digits) ,

ASCII visible code (0x20~0x7E) can only be printed.



In the case of an invisible code other than 0x0D, print in the space 0x20.

ASCII	<b>ID (Max 16 digits)</b>	<b>CR</b>
-------	---------------------------	-----------

※For transmission format of the ID reader, please set as follows.

Setting items	Setting value
Prefix	no
Code ID	no
Number of data digits	no
Data	1~16 digits
Postfix	<b>CR</b> (0 x 0D)

- 3) Set the external I/O protocol setting F20 "3", the communication speed(F22), and then set to match stop bit(F24) to the ID reader.  
 In addition, since TM-2657 is fixed the data length and parity, please set the setting of the ID reader to "data length:8 bit, "parity:None".

Setting items	Contents	Set value	Function
F20	External I/O protocol	3	Connecting terminal :Blood pressure result input and output (STD/RI/RB/BP/RA) Connecting terminal : ID reader
F22	Connecting terminal Communication speed 	120	1200 bps
		240	2400 bps (default)
		480	4800 bps
		960	9600 bps
F24	Connecting terminal Stop bit 	1	Stop bit : 1(default)
		2	Stop bit : 2

4) ID printing setting

In the case of printing the ID information, please set F07 setting to "ID field: yes".

Setting items	contents	Set value	function
F07	Printing	oFF	ID field : No / name field : No
		1	ID field : No/ name field : Yes
		2	ID field : Yes / name field : No
		3	ID field : Yes / name field : Yes

Printing example) ID field : Yes / Name field : No

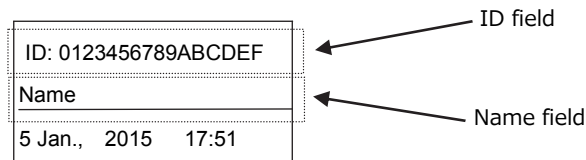

- ID data is stored until the blood pressure is measured correctly, canceled, or the power is turned OFF. Then the data is cleared immediately after printing or displayed.
- When receiving the ID information more than once, set the last received ID information as the valid ID data.



# 10 A&D Co.,Ltd. height and weight scale connection

## 10.1 System example

Connected to the A&D manufactured height and weight meter or scales, the result of height and weight value by the following F16 settings can be printed by the printer of the TM2657 only when the TM2657 is connected to the A&D manufactured height and weight scale, and set the external I/O protocol F20 to "2" or "6".

Printing format and printing timing can be selected from the printer mode and integration mode.

Also, it is possible to output the height value, weight value and blood pressure value to the PC by receiving the ID information read by ID reader to connect with the height-weight/weight scale.

### 1) Height-weight scale (Mini-DIN connecting) , PC (D-Sub connecting)

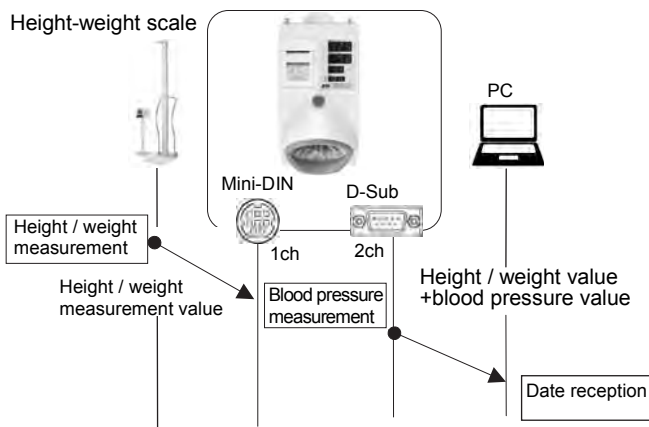

#### [Function setting]

Connecting device **F20:[ 2 ]** ch1:Height-weight scale  
ch2:Measurement result output

Measurement result output **F25** (RB / RI / BP / STD/ RA )

#### [ch1 communication setting]

Baud rate 2400 ( fixed )  
Startbit 1 (fixed)  
Data length 7 (fixed)  
Parity Even (fixed)  
Stopbit **F23** ( 1 / 2 )

#### [ch2 communication setting]

Baud rate **F22** ( 1200 / 2400 / 4800 / 9600 )  
Startbit 1 (fixed)  
Data length 8 (fixed)  
Parity None (fixed)  
Stopbit **F24** ( 1 / 2 )

### 2) PC (Mini-DIN connecting) , Height-weight scale (D-Sub connecting)

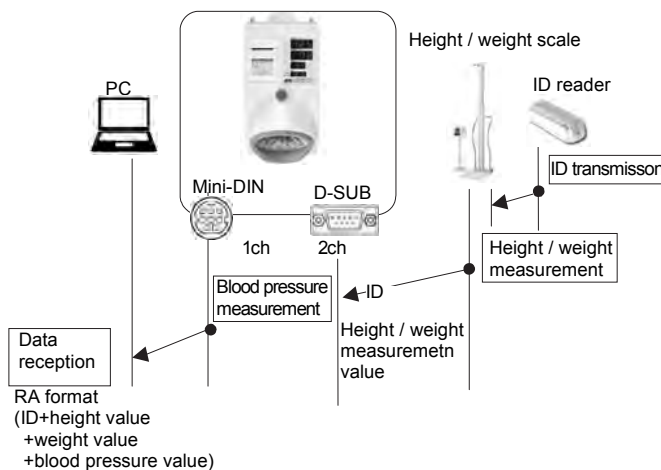

#### [Function setting]

Connecting device **F20:[ 6 ]** ch1: Measurement result output  
ch2: Height-weight scale

Measurement result output **F25** (RB / RI / BP / STD/ RA )

#### [ch1 communication setting]

Baud rate **F21** ( 1200 / 2400 / 4800 / 9600 )  
Startbit 1 (fixed)  
Data length 8 (fixed)  
Parity None (fixed)  
Stopbit **F23** ( 1 / 2 )

#### [ch2 communication setting]

Baud rate 2400 ( fixed )  
Startbit 1 (fixed)  
Data length 7 (fixed)  
Parity Even (fixed)  
Stopbit **F24** ( 1 / 2 )

## 10.2 Setting of height and weight value printing

The result of height and weight value by the following F16 settings can be printed by the printer of the TM2657 only when the TM2657 is connected to the A&D manufactured height and weight scale, and set the external I/O protocol F20 to "2" or "6".

Printing format and printing timing can be selected from the printer mode and integration mode.

Setting item	Contents	Setting value	Function
F16	Height-weight value printing setting	oFF	Height and weight value printing OFF
		1	Printer mode
		2	Integrated mode (default)

### 1) Printer mode

Immediately after that was measured by height and weight meter or weight scale, TM-2657 prints the received measurement result (height value, weight value) in the following patterns as packets.

However, height value and weight value etc cannot be received during blood pressure measurement.

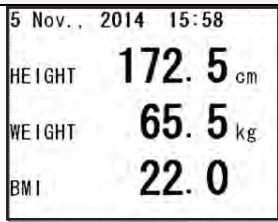
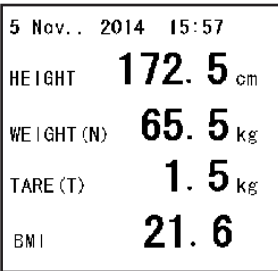
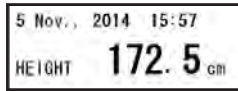
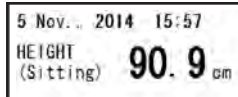
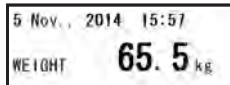
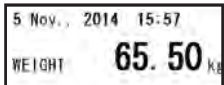
Received data (connecting device example)	Printing pattern
Received data : Height value, Weight value, BMI (Height-weight scale AD-6228A)	
Received data : Height value, Weight value, preset tare, BMI (Height-weight scale AD-6228A) ※When tared (along with the subscript) (N) : NET Net amount obtained by subtracting the tare weight from the total amount (T) : TARE Tare, actual measured mass such as clothing (PT) : Preset Tare Tare the set value, prior to assuming a mass, such as clothing	
Received data : Height value (Height meter : AD6400)	Height value  Sitting height value 
Received data : Weight value (Weight scale : AD6209)	Minimum first amount 100g    Minimum first amount 50g (one decimal place)            (two decimal places)  

2) Integrated mode

After measuring height scale or weight scale, blood pressure measurement printing occurs with the following pattern in the header portion of the blood pressure value printing.

The height and weight data are held until either the blood pressure is measured correctly or the power supply is off, then cleared immediately after printing or displaying the data.

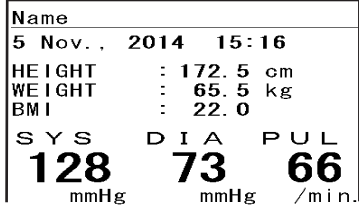
Received data (connecting device example)	Printing pattern
Received data : Height value, weight value, BMI (Height-weight scale AD-6228A)	 <pre> Name 5 Nov. , 2014 15:16 HEIGHT : 172.5 cm WEIGHT : 65.5 kg BMI : 22.0 SYS DIA PUL 128 73 66 mmHg mmHg /min.           </pre> <p>※When there is no measurement result, the print value is “---”.</p>

※Devices that can be connected.

Full automatic height and weight scale : AD-6228A/AD-6228AP

Digital height scale : AD-6400

Digital height-weight scale : AD-6351

Bed side scale : AD-6121A/AD-6122

Precision scale with test : AD-6207A/AD-6208B



Barrier freescale : AD-6105N/AD-6106N/AD-6107N

Commercial weight scale : AD-6209/AD-6210

# 11 ICT printing

## 11.1 ICT printing example (F29)

Depending on the setting of F29, the measurement results print CODE39 bar code or QR code.

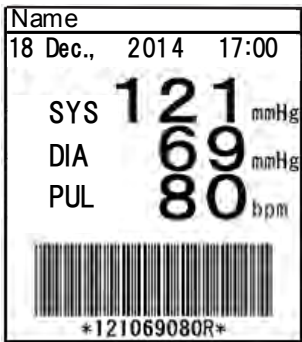
F29 setting	Printing example	ICT format	Information
OFF	No printing	-	-
1		<p>CODE39 barcode (v1)</p> <p>(There is a MAP, no check digit)</p>	<p>Systolic blood pressure values, average blood pressure value (MAP) , diastolic blood pressure, pulse rate</p>
2		<p>QR code (v1)</p>	<p>Year,month,date,time,sec, ID(16 digits), Systolic blood pressure values, average blood pressure value, diastolic blood pressure, pulse rate</p>
3		<p>CODE39 barcode (v2)</p> <p>(No map, there is a check digit)</p>	<p>Systolic blood pressure values, Diastolic blood pressure, Pulse rate</p> <p>There is a check digit (Modulus 43)</p>

4		QR code (v2)	<p>Year,month,date,time,sec,  ID(16 digits), Systolic blood pressure  values, average blood pressure  value (MAP) , diastolic blood  pressure, pulse rate, height value,  weight value, etc</p>
---	---	--------------	---

## 11.2 CODE39 barcode (V1) data format

### 1)Specification

Check digit presence or absence : None

Mean arterial blood pressure (map) data : Yes

### 2)Data format

Byte	0	1	2	3	4	5	6	7	8	9	10	11
ASCII	sys			map			dia			pul		

※Stored value

Identifier	Byte	Blood pressure measurement (normal) result
sys	3	<Measurement start time> sys : Systolic blood pressure [mmHg] map : Mean arterial blood pressure [mmHg] dia : Diatolic blood pressure [mmHg] pul: Pulse rate [bpm] ※Zero padding
map	3	
dia	3	
pul	3	

3)Data example Systolic blood pressure =113[mmHg], Mean arterial blood pressure =95[mmHg], Diatolic blood pressure =75[mmHg],

Pulse rate =66[bpm]

Byte	0	1	2	3	4	5	6	7	8	9	10	11
ASCII	'1'	'1'	'3'	'0'	'9'	'5'	'0'	'7'	'5'	'0'	'6'	'6'
Hex	0x31	0x31	0x33	0x30	0x39	0x35	0x30	0x37	0x35	0x30	0x36	0x36

## 11.3 CODE39 barcode (V2) data format

### 1)Specification

Check digit presence or absence : Yes

Average blood pressure (map) data : None

### 2)Data format

Byte	0	1	2	3	4	5	6	7	8	9
ASCII	sys			dia			pul			C/D

※Stored value

Identifier	Byte	Blood pressure measurement (normal) result
sys	3	<Measurement result> sys : Systolic blood pressure [mmHg] dia : Diatolic blood pressure [mmHg] pul: Pulse rate [bpm] ※Zero padding
dia	3	
pul	3	
C/D	1	Modulus 43method of check digit

3) Data example Systolic blood pressure =113[mmHg], Diatolic blood pressure =75[mmHg], Pulse rate =66[bpm]

Byte	0	1	2	3	4	5	6	7	8	9
ASCII	'1'	'1'	'3'	'0'	'7'	'5'	'0'	'6'	'6'	'T'
Hex	0x31	0x31	0x33	0x30	0x37	0x35	0x30	0x36	0x36	0x54

# 11.4 QR code (V1) data format.

## 1)Specification

QR error correction level : level L (About 7% of codewords can be restored.)

QR version : 3 ( symbolsize=29 )

## 2)Data format

Byte	0	1	2	3	4	5	6	7	8	9	10	11	12	13	14	15	
ASCII	'<'	'T'	year				month		day		hour		minute		' '	id→	
	16	17	18	19	20	21	22	23	24	25	26	27	28	29	30	31	
	←id (16 桁)															'S'	
	32	33	34	35	36	37	38	39	40	41	42	43	44	45	46	47	
	sys			'M'	map			'D'	dia			'P'	pul		'>'		

※Stored value

Identifier	Byte	Blood pressure measurement (normal) result
year	4	<Measurement start time > year : To store the year the last four digits. The setting range is from '2015' to '2050'. month : To store the value of the month. The setting range is from '01' to '12'. day : To store the value of the day. The setting range is from '01' to '31'. hour : To store the value of the current time. The setting range is from '00' to '23'. Minute : To store the value of the current minute. The setting range is from '00' to '59'. ※Zero padding Ex) '01' : 0x30 0x31
month	2	
day	2	
hour	2	
minute	2	
id	16	Store the ID. Left- justified, margins are filled with 0x20.
sys	3	<Measurement result> sys : Systolic blood pressure [mmHg] map : Mean arterial blood pressure [mmHg] dia : Diatolic blood pressure [mmHg] pul: Pulse rate [bpm] ※Zero padding
map	3	
dia	3	
pul	3	

## 3)Data example Date and time of measurement=Januare 1, 2015 AM 0:03 ID="TEST-TM2657\_QR"

Systolic blood pressure=113[mmHg], Mean arterial blood @pressure[mmHg], diatolic blood pressure=75[mmHg], Pulse rate=66[bpm]

Byte	0	1	2	3	4	5	6	7	8	9	10	11	12	13	14	15
ASCII	'<'	'T'	'2'	'0'	'1'	'5'	'0'	'1'	'0'	'1'	'0'	'0'	'0'	'3'	' '	'T'
Hex	0x3c	0x54	0x32	0x30	0x31	0x35	0x30	0x31	0x30	0x31	0x30	0x30	0x30	0x33	0x49	0x54
	16	17	18	19	20	21	22	23	24	25	26	27	28	29	30	31
	'E'	'S'	'T'	' '	'T'	'M'	'2'	'6'	'5'	'7'	' '	'Q'	'R'	' '	' '	'S'
	0x45	0x53	0x54	0x2d	0x54	0x4d	0x32	0x36	0x35	0x37	0x5f	0x51	0x52	0x20	0x20	0x53
	32	33	34	35	36	37	38	39	40	41	42	43	44	45	46	47
	'1'	'1'	'3'	'M'	'0'	'9'	'5'	'D'	'0'	'7'	'5'	'P'	'0'	'6'	'6'	'>'
	0x31	0x31	0x33	0x4d	0x30	0x39	0x35	0x44	0x30	0x37	0x35	0x50	0x30	0x36	0x36	0x3e

# 11.5 QR code (V2) data format

## 1) Specification

QR error correction level : level L (About 7% can be stored to the entire code word.)

QR version : 8 ( symbolsize=49 )

## 2) Data format

Byte	0	1	2	3	4	5	6	7	8	9	10	11	12	13	14	15
ASCII	'<	RS	'h'	height				RS	's'	sit				RS		
	16	17	18	19	20	21	22	23	24	25	26	27	28	29	30	31
	'l'	id(16 digits)→														
	32	33	34	35	36	37	38	39	40	41	42	43	44	45	46	47
	←id	RS	'T'	year			month		day		hour		minute		sec	
	48	49	50	51	52	53	54	55	56	57	58	59	60	61	62	63
	sec	RS	'S'	sys			RS	'M'	map			RS	'D'	dia		
	64	65	66	67	68	69	70	71	72	73	74	75	76	77	78	79
	RS	'P'	pul		RS	'i'	ihb		RS	'm'	moti	RS	'r'	reme	RS	
	80	81	82	83	84	85	86	87	88	89	90	91	92	93	94	95
	'c'	ssw	RS	't'	mtime			RS	'w'	weight				RS		
	96	97	98	99	100	101	102	103	104	105	106	107	108	109	110	111
	'f'	tare					RS	'e'	pretare					RS		
	112	113	114	115	116	117	118	119	120	121	122	123	124	125	126	127
	'b'	bmi					RS	'K'	model(15 桁)→							
	128	129	130	131	132	133	134	135	136	137	138	139	140	141	142	143
	←model						RS	'C'	mserial(12 桁)→							
	144	145	146	147	148	149	150	151	152	153	154	155	156	157	158	159
	←mserial					RS	'Q'	qrver			RS	'B'	bserial(12 桁)→			
	160	161	162	163	164	165	166	167	168	169	170	171	172	173	174	175
	←bserial								RS	'O'	mcount→					
	176	177														
	←mcount	'>														



※Stored value

Identifier	Byte	Blood pressure measurement (normal) result
height	5	Store the height value [cm]. Integer part zero suppression, enable one decimal digit. When there is no value, it is all SP (0x20).
sit	5	Store the sitting height value [cm]. Integer part zero suppression, enable one decimal digit. When there is no value, it is all SP (0x20).
id	16	Store the ID 16digits Printable ASCII. Left-justified, margins are filled with "0x20".
year	4	<Measurement start time > year : To store the year tha last four digits. The setting range is from '2015' to '2050'. month : To store the value of the month. The setting range is from '01' to '12'. day : To store the value of the day. The setting range is from '01' to '31'. hour : To store the value of the current time. The setting range is from '00' to '23'. minute : To store the value of the current minute. The setting range is from '00' to '59'. sec : To store the value of the current second. The setting range is from '00' to '59'. ※Zero padding Ex) '01' : 0x30 0x31
month	2	
day	2	
hour	2	
minute	2	
sec	2	
sys	3	
map	3	
dia	3	
pul	3	
ihb	2	Store an irregula pulse number[times] . zero suppression
moti	1	Store motion[0:No/1:Yes]
reme	1	Store the re-measurement number of times[times]
ssw	1	Store the measurement start SW identification code (L:left /R:right /N:no distinction)
mtime	3	Store the measurement time[sec], zero suppression.
weight	6	Store the weight value[kg], Integer part zero suppression, enable decimal digits1~2. In case of enable one decimal digit, the second digit is the SP(0x20). When there is no value, it is all SP(0x20).
tare	6	Store the tare value[kg]. Integer part zero suppression, enable decimal digits1~2, In case of enable one decimal digit,the second digit is the SP(0x20).If there is no value, it is all SP(0x20).
pretare	6	Store the preset tare value[kg]. Integer part zero suppression, In case of enable one decimal digit,the second digit is the SP(0x20). If there is no value, it is all SP(0x20).
bmi	6	Store the BMI value. Integer part zero suppression, In case of enable one decimal digit,the second digit is the SP(0x20).If there is no value, it is all SP(0x20).
model	15	Store the model code (the model name)15 digit Printable ASCII. Left-justified, margins are filled with "0x20".
mserial	12	Store the model serial code 12 digit Printable ASCII. Left-justified, margins are filled with "0x20".
qrver	4	Store the QRv2 format version.And stores the 4 digit Printable ASCII. Left-justified, margins are filled with "0x20".
bpserial	12	Store the BP module (Tm2915) serial code. And stores the 12 digit Printable ASCII. Left-justified, margins are filled with "0x20".
mcount	6	Store the unit total number of measurements [times] zero suppression.

3) Data example Date and time of measurement=January 1,2015, AM 0,3minutes,5seconds,height=168.2[cm]、 sitting height=none, ID="TEST-TM2657\_QR"、 systolic blood pressure=113[mmHg]、 mean arterial blood pressure=95[mmHg]、 Diastolic blood pressure=75[mmHg]、 Pulse rate=66[bpm]、 IHB=5[time]、 Body motion=Yes, Re-measure the number of times=1[time]、 Measurement start SW=no distinction, measurement time=68[second]、Weight=58.1[kg]、 Tare=10.0[kg]、 Preset tare=none, BMI=20.5, model code="TM2657PEG",

medel serial code="987654-32", QRv2 format version="Q001", BP module serial code="DUMMY-SN",

This unit total number of measurements=349[time]

Byte	0	1	2	3	4	5	6	7	8	9	10	11	12	13	14	15
ASCII	'<	RS	'h'	'1'	'6'	'8'	'.'	'2'	RS	's'	'.'	'.'	'.'	'.'	'.'	RS
Hex	0x3c	0x1e	0x68	0x31	0x36	0x38	0x2e	0x32	0x1e	0x73	0x20	0x20	0x20	0x20	0x20	0x1e
	16	17	18	19	20	21	22	23	24	25	26	27	28	29	30	31
ASCII	'l'	'T'	'E'	'S'	'T'	'.'	'T'	'M'	'2'	'6'	'5'	'7'	'.'	'Q'	'R'	'.'
Hex	0x49	0x54	0x45	0x53	0x54	0x2d	0x54	04dx	0x32	0x36	0x35	0x37	0x5f	0x51	0x52	0x20
	32	33	34	35	36	37	38	39	40	41	42	43	44	45	46	47
ASCII	'.'	RS	'T'	'2'	'0'	'1'	'5'	'0'	'1'	'0'	'1'	'0'	'0'	'0'	'3'	'0'
Hex	0x20	0x1e	0x54	0x32	0x30	0x31	0x35	0x30	0x31	0x30	0x31	0x30	0x30	0x30	0x33	0x30
	48	49	50	51	52	53	54	55	56	57	58	59	60	61	62	63
ASCII	'5'	RS	'S'	'1'	'1'	'3'	RS	'M'	'.'	'9'	'5'	RS	'D'	'.'	'7'	'5'
Hex	0x35	0x1e	0x53	0x31	0x31	0x33	0x1e	0x4d	0x20	0x39	0x35	0x1e	0x44	0x20	0x37	0x35
	64	65	66	67	68	69	70	71	72	73	74	75	76	77	78	79
ASCII	RS	'P'	'.'	'6'	'6'	RS	'i'	'.'	'5'	RS	'm'	'1'	RS	'r'	'1'	RS
Hex	0x1e	0x50	0x20	0x36	0x36	0x1e	0x69	0x20	0x35	0x1e	0x6d	0x31	0x1e	0x72	0x31	0x1e
	80	81	82	83	84	85	86	87	88	89	90	91	92	93	94	95
ASCII	'c'	'N'	RS	'i'	'.'	'6'	'8'	RS	'w'	'.'	'5'	'8'	'.'	'1'	'.'	RS
Hex	0x63	0x4e	0x1e	0x74	0x20	0x36	0x38	0x1e	0x77	0x20	0x35	0x38	0x2e	0x31	0x20	0x1e
	96	97	98	99	100	101	102	103	104	105	106	107	108	109	110	111
ASCII	'f'	'.'	'1'	'0'	'.'	'0'	'.'	RS	'e'	'.'	'.'	'.'	'.'	'.'	'.'	RS
Hex	0x66	0x20	0x31	0x30	0x2e	0x30	0x20	0x1e	0x65	0x20	0x20	0x20	0x20	0x20	0x20	0x1e
	112	113	114	115	116	117	118	119	120	121	122	123	124	125	126	127
ASCII	'b'	'.'	'2'	'0'	'.'	'5'	RS	'K'	'T'	'M'	'2'	'6'	'5'	'7'	'P'	'E'
Hex	0x62	0x20	0x32	0x30	0x2e	0x35	0x1e	0x4b	0x54	0x4d	0x32	0x36	0x35	0x37	0x50	0x45
	128	129	130	131	132	133	134	135	136	137	138	139	140	141	142	143
ASCII	'G'	'.'	'.'	'.'	'.'	'.'	'.'	RS	'C'	'9'	'8'	'7'	'6'	'5'	'4'	'.'
Hex	0x47	0x20	0x20	0x20	0x20	0x20	0x20	0x1e	0x43	0x39	0x38	0x37	0x36	0x35	0x34	0x2d
	144	145	146	147	148	149	150	151	152	153	154	155	156	157	158	159
ASCII	'3'	'2'	'.'	'.'	'.'	RS	'Q'	'Q'	'0'	'0'	'1'	RS	'B'	'D'	'U'	'M'
Hex	0x33	0x32	0x20	0x20	0x20	0x1e	0x51	0x51	0x30	0x30	0x31	0x1e	0x42	0x44	0x55	0x4d
	160	161	162	163	164	165	166	167	168	169	170	171	172	173	174	175
ASCII	'M'	'Y'	'.'	'S'	'N'	'.'	'.'	'.'	RS	'O'	'.'	'.'	'.'	'.'	'3'	'4'
Hex	0x4d	0x59	0x2d	0x53	0x4e	0x20	0x20	0x20	0x20	0x1e	0x4f	0x20	0x20	0x20	0x33	0x34
	176	177														
ASCII	'g'	'>														
Hex	0x39	0x3e														

---

## 12 Error code (TM-2657)

---

### 12.1 Overview of the error

Depending on the error at the time of measurement, the following error codes using communication output format are issued.

Error code	Contents
E00	Successful completion
E11、E15	Pressure is not applied at the start of the measurement.
E12	Pressure cannot be applied within a certain period of time.
E13	Inflation speed is too fast.
E21	The exhaust speed is too slow.
E22	The exhaust speed is too fast.
E23	Excess pressure was detected.
E24	The time limit for one measurement was exceeded.
E42	The pressure is insufficient.
E43	Pulse cannot be detected.
E44	There is a body movement.
E45	Diastolic blood pressure cannot be determined.
E46	Mean arterial blood pressure cannot be determined.
E48	Systolic blood pressure cannot be determined.
E61	Pulse cannot be determined.
E63	The blood pressure value is inappropriate.



**A&D Company, Limited**

3-23-14 Higashi-Ikebukuro, Toshima-ku, Tokyo 170-0013, JAPAN  
Telephone: [81] (3) 5391-6132 Fax: [81] (3) 5391-6148