



Digital Blood Pressure Monitor

Model UA-789XL

Instruction Manual
Original

ENGLISH

Manuel d'instructions
Traduction

FRANÇAIS

Manual de Instrucciones
Traducción

ESPAÑOL

Manuale di Istruzioni
Traduzione

ITALIANO

Bedienungsanleitung
Übersetzung

DEUTSCH

使用手冊
翻譯

中文

Contents

Dear Customers	1
Preliminary Remarks	2
Precautions	2
Parts Identification	3
Symbols	4
Operation Mode	5
Using The Monitor	6
Installing / Changing The Batteries	6
Connecting The Air Hose	6
Connecting The AC adapter	6
Adjusting The Built-in Clock	7
Setting Three Reminders	7
Alarm ON/OFF Mark On The Display	8
Selecting The Correct Cuff	8
Applying The Arm Cuff	8
How To Take Proper Measurements	9
Measurement	9
After Measurement	9
Measurements	10
Normal Measurement	10
Measurement With The Desired Systolic Pressure	11
Notes For Proper Measurement	11
Recalling Memory Data	12
What Is An Irregular Heartbeat	12
Pressure Bar Indicator	12
WHO Classification Indicator	13
About Blood Pressure	13
What Is Blood Pressure?	13
What Is Hypertension And How Is It Controlled?	13
Why Measure Blood Pressure At Home?	13
WHO Blood Pressure Classification	14
Blood Pressure Variations	14
Troubleshooting	15
Maintenance	15
Technical Data	16

Dear Customers

Congratulations on purchasing a state-of-the-art A&D blood pressure monitor, one of the most advanced monitors available today. Designed for ease of use and accuracy, this device will facilitate your daily blood pressure regimen.

We recommend that you read through this manual carefully before using the device for the first time.

Preliminary Remarks

- This device conforms to the European Directive 93/42 EEC for Medical Products. This is made evident by the **CE**₀₁₂₃ mark of conformity.
(0123: The reference number to the involved notified body)
- The device is designed for use on adults only, not newborns or infants.
- Environment for use. The device is for use in the home healthcare environment.
- This device is designed to measure blood pressure and pulse rate of people for diagnosis.

Precautions

- This device is designed for big arm. This device is not designed for using the medium and small cuff. Only use Large cuff or Extra Large cuff.

Arm Size	Recommended Cuff Size	Catalog Number
32 cm to 45 cm	Large adult cuff	CUF-D-LA
42 cm to 60 cm	Extra large adult cuff	CUF-B-XLA

Arm size : The circumference of the biceps

- Precision components are used in the construction of this device. Extremes in temperature, humidity, direct sunlight, shock or dust should be avoided.
- Clean the device and cuff with a dry, soft cloth or a cloth dampened with water and a neutral detergent. Never use alcohol, benzene, thinner or other harsh chemicals to clean the device or cuff.
- Avoid tightly folding the cuff or storing the hose tightly twisted for long periods, as such treatment may shorten the life of the components.
- The device and cuff are not water resistant. Prevent rain, sweat and water from soiling the device and cuff.
- Measurements may be distorted if the device is used close to televisions, microwave ovens, cellular telephones, X-ray or other devices with strong electrical fields.
- Used equipment, parts and batteries are not treated as ordinary household waste, and must be disposed of according to the applicable local regulations.
- When the AC adapter is used, make sure that the AC adapter can be readily removed from the electrical outlet when necessary.
- When reusing the device, confirm that the device is clean.
- Do not modify the device. It may cause accidents or damage to the device.
- To measure blood pressure, the arm must be squeezed by the cuff hard enough to temporarily stop blood flow through the artery. This may cause pain, numbness or a temporary red mark to the arm. This condition will appear especially when measurement is repeated successively. Any pain, numbness, or red marks will disappear with time.

Contraindications







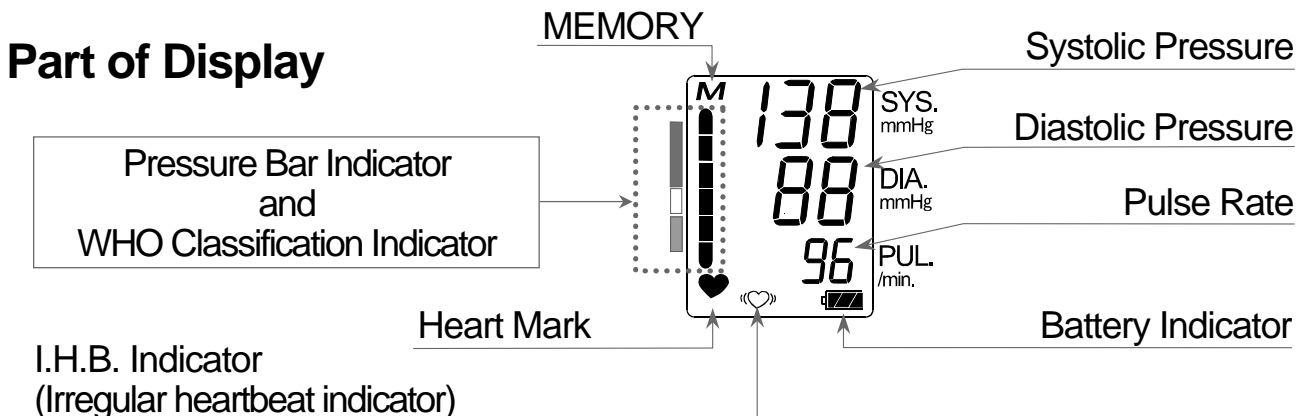
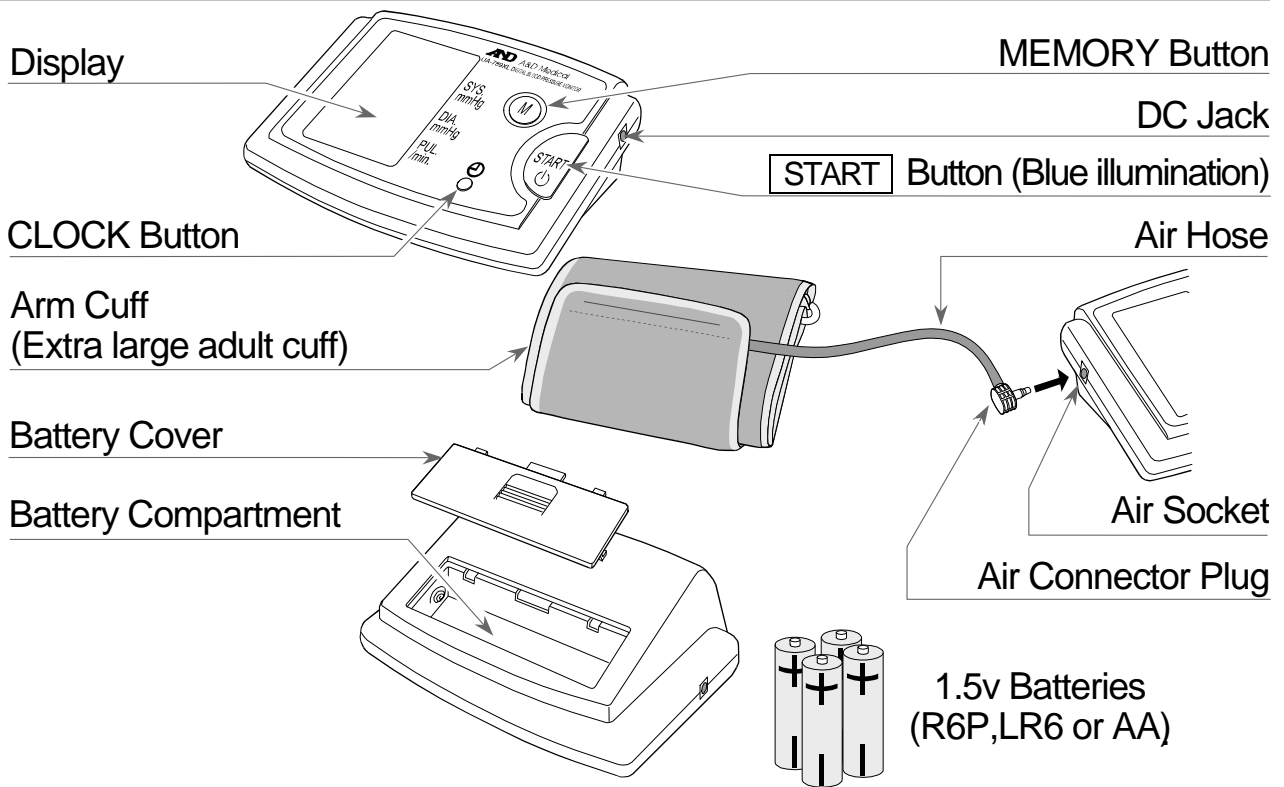





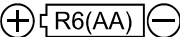



The following are precautions for proper use of the device.



- People who have a severe circulatory deficit in the arm must consult a doctor before using the device, to avoid medical problems.
- Do not self-diagnose the measurement results and start treatment by yourself. Always consult your doctor for evaluation of the results and treatment.
- Do not apply the cuff on an arm with an unhealed wound.
- Do not apply the cuff on an arm receiving an intravenous drip or blood transfusion. It may cause injury or accidents.
- Do not use the device where flammable gases such as anesthetic gases are present. It may cause an explosion.
- Do not use the device in highly concentrated oxygen environments, such as a high-pressure oxygen chamber or an oxygen tent. It may cause a fire or explosion.

Parts Identification



Symbols

Symbols	Function / Meaning	Recommended Action
	Standby and Turn the device on.	—————
	CLOCK button mark	If you want to stop the sound, press the START button.
	Alarm ON/OFF mark of the reminder	
SYS.	Systolic blood pressure in mmHg	—————
DIA.	Diastolic blood pressure in mmHg	—————
PUL./min.	Pulse per minute	—————
	Battery installation guide	—————
	Direct current	—————
	Type BF: Device, cuff and tubing are designed to provide special protection against electrical shocks.	—————
	The indicator while measurement is in progress. It blinks while detecting the pulse.	Measurement is in progress. Remain as still as possible.
	Irregular H ear t beat indicator. (I.H.B.) The indicator that detects irregular heartbeats or any excessive body movement during the measurement.	—————
M	Previous measurements stored in MEMORY.	—————
 Full Battery	The battery power indicator during measurement.	—————
 Low Battery	The battery is low when it blinks.	Replace all batteries with new ones, when the indicator blinks.
Err	Unstable blood pressure due to movement during the measurement.	Try measurement again. Remain very still during the measurement.
	The systolic and diastolic values are within 10 mmHg of each other.	Fasten the cuff correctly, and try the measurement again.
	The pressure value did not increase during inflation.	
	The cuff is not fastened correctly.	Fasten the cuff correctly, and try the measurement again.
	The pulse is not detected correctly.	
	EC directive medical device label	—————
	EU-representative	—————
	Manufacturer	—————
	Date of manufacture	—————
	Class II device	—————

Symbols	Function / Meaning	Recommended Action
	WEEE label	_____
	Refer to instruction manual/booklet	_____
SN	Serial number	_____
	Polarity of DC jack	_____

Operation Mode

1. Normal Measurement With Storing Data (Refer to page 10)

Press the **START** button. Blood pressure is measured and data is stored within the device. The device can store the last sixty sets of data in memory automatically.

2. Recalling Data (Refer to page 12)

Press the **MEMORY** button to recall the data. The date and the most recent data are displayed.

The device can store the last sixty sets of data in memory automatically.

Press the **MEMORY** button

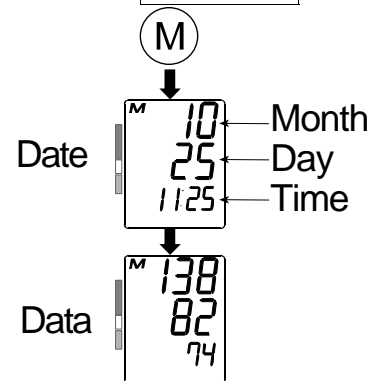

3. Clearing Data (Refer to page 12)

Press and hold the **MEMORY** button until the "M" (memory) mark blinks to clear the stored data.

4. Measurement With The Desired Systolic Pressure

Refer to page 11 for the measurement with the desired systolic pressure.



Using The Monitor

Installing / Changing The Batteries

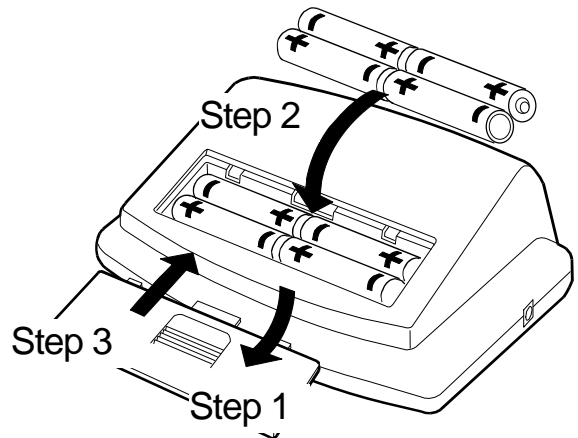
1. Slide the battery cover up to open it.
2. Remove the used batteries and insert new batteries into the battery compartment as shown, taking care that the polarities (+) and (-) are correct.
3. Slide the battery cover down to close it.
Use only R6P, LR6 or AA batteries.



CAUTION

- Insert the batteries as shown in the battery compartment. If not, the device will not work.
- When  (LOW BATTERY mark) blinks on the display, replace all batteries with new ones. Do not mix old and new batteries. It may shorten the battery life, or cause the device to malfunction.
-  (LOW BATTERY mark) does not appear when the batteries are drained.
- Battery life varies with the ambient temperature and may be shorter at low temperatures.
- Use the specified batteries only. The batteries provided with the device are for testing monitor performance and may have a limited life.
- Remove the batteries if the device is not to be used for a long time. The batteries may leak and cause a malfunction.
- Stored data are cleared when the batteries are removed.

Connecting The Air Hose

Insert the air connector plug into the air socket firmly.

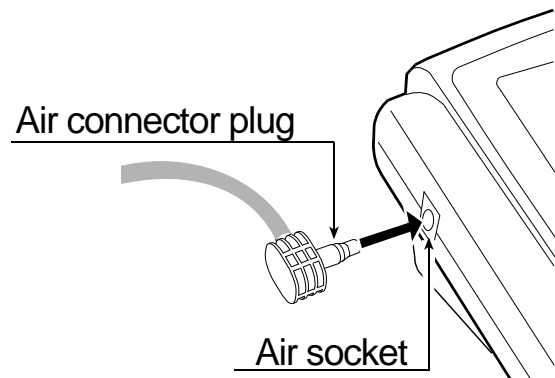

Connecting The AC adapter

Insert the AC adapter plug into the DC jack. Next, connect the AC adapter to an electrical outlet.

- Use the specified AC adapter.
(Refer to page 16)

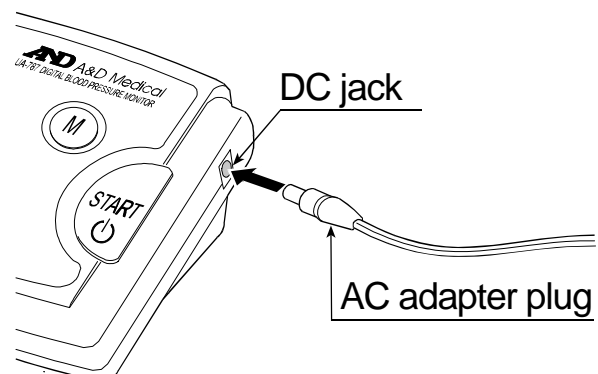

Using The Monitor

Adjusting The Built-in Clock

The device has a built-in clock.

We recommend that you adjust the clock prior to use.

1. Press and hold the **CLOCK** button until the digits start blinking.

2. Select the year using the **START** button.

Press the **CLOCK** button to set the current year and move to month/day selection. The date can be set anywhere between the years 2004 and 2053.

3. Select the month using the **START** button.

Press the **CLOCK** button to set the current month and move to day selection.

4. Select the day using the **START** button.

Press the **CLOCK** button to set the current day and move to hour/minute selection.

5. Select the hour using the **START** button.

Press the **CLOCK** button to set the current hour and move to minute selection.

6. Select the minute using the **START** button.

Press the **CLOCK** button to set the current minute and activate the clock.

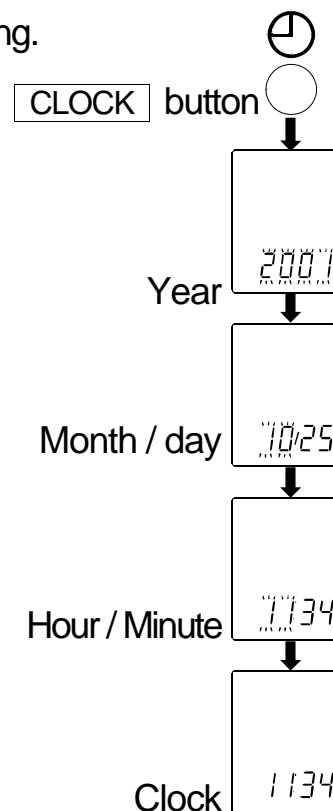

Setting Three Reminders

This device has 3 reminder alarms. You can set 3 different reminder alarms within a 24-hour period.

1. Press and hold the **CLOCK** button until the digits start blinking. Then press the **MEMEORY** button.

“P-1” is shown at the middle line of the display.

2. Select the hour using the **START** button and press the **CLOCK** button to set the hour and move to minute selection. Press the **MEMORY** button to complete the reminder setting after selecting the minute.

3. Then the display shows “P-2” for the second reminder. Repeat the above process if you need a second reminder.

4. A third reminder can be set as well.

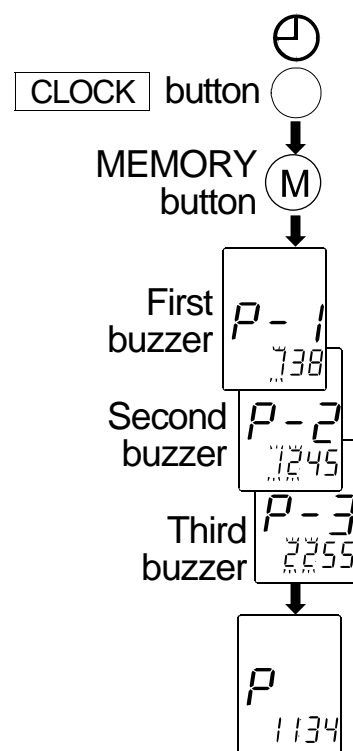

Using The Monitor

Alarm ON/OFF Mark On The Display

When the alarm is on, a “p” appears on the LCD. To turn the alarm off, simply press the **CLOCK** button once. The alarm will sound for 1 minute. To stop the alarm sound, press the **START** button once.

Selecting The Correct Cuff

Using the correct cuff size is important for an accurate reading. If the cuff is not the proper size, the reading may yield an incorrect blood pressure value.



- The arm size is printed on each cuff.
- The arm cuff is a consumable. If it becomes worn, purchase a new one.

Arm Size	Recommended Cuff Size	Catalog Number
32 cm to 45 cm	Large adult cuff	CUF-D-LA
42 cm to 60 cm	Extra large adult cuff	CUF-B-XLA

Arm size: The circumference at the biceps.

Note: Model UA-789XL is not designed for using a small adult cuff.

Symbols printed on the cuff.

Symbols	Function / Meaning	Recommended Action
	Artery position mark	Set the  mark on the artery of the upper arm or in line with the ring finger on the inside of the arm.
REF	Catalog number	_____
LOT	Lot number	_____

Applying The Arm Cuff

1. Wrap the cuff around the upper arm, about 1 to 2 cm above the inside of the elbow, as shown. Place the cuff directly against the skin, as clothing may cause a faint pulse and result in a measurement error.
2. Constriction of the upper arm, caused by rolling up a shirtsleeve, may prevent accurate readings.

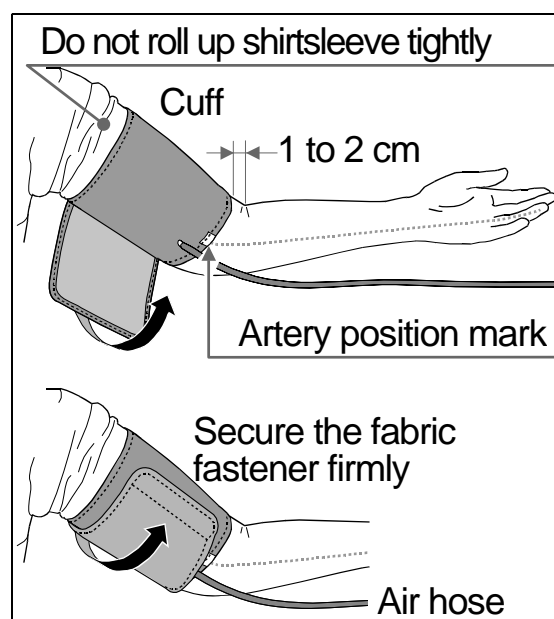

How To Take Proper Measurements

For the most accurate blood pressure measurement:

- Sit comfortably on a chair. Rest your arm on the table. Do not cross your legs. Keep your feet on the floor and straighten your back.
- Relax before measurement.
- Place the center of the cuff at the same height as your heart.
- Remain still and keep quiet during measurement.
- Do not measure right after physical exercise or a bath. Rest before taking the measurement.
- Try to measure your blood pressure at the same time every day.

Measurement

During measurement, it is normal for the cuff to feel very tight. (Do not be alarmed).

After Measurement

After measurement, press the START button to turn off the power. Remove the cuff and record your data.

Note: The device has an automatic power shut-off function, which turns the power off automatically one minute after measurement.

Allow at least three minutes between measurements on the same person.

Measurements

Model UA-789XL is designed to detect the pulse and to inflate the cuff to a systolic pressure level automatically. If your systolic pressure is expected to exceed 230 mmHg, read "**Measurement With The Desired Systolic Pressure**" on the next page.

Normal Measurement

1. Place the cuff on the arm (preferably the left arm).
Sit quietly during measurement.

2. Press the **START** button.

The average blood pressures and last data number are displayed briefly. Then the display changes, as indicated in the figure at the right, as the measurement begins. The cuff starts to inflate. It is normal for the cuff to feel very tight. A pressure bar indicator is displayed, as in the figure at the right, during inflation.

Note: If you wish to stop inflation at any time, press the **START** button again.

3. When inflation is complete, deflation starts automatically and  (heart mark) blinks, indicating that the measurement is in progress. Once the pulse is detected, the mark blinks with each pulse beat.

Note: If an appropriate pressure is not obtained, the device starts to inflate again automatically.

4. When the measurement is complete, the systolic and diastolic pressure readings and pulse rate are displayed. The cuff exhausts the remaining air and deflates completely.

5. Press the **START** button again to turn off the power.

Note: Model UA-789XL is provided with an automatic power shut-off function.

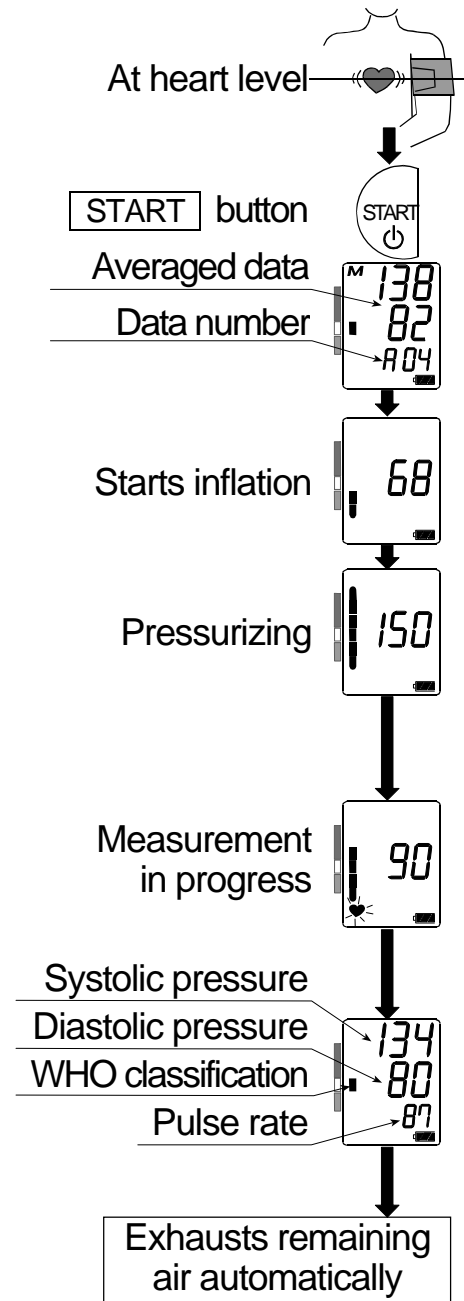

Measurements

Measurement With The Desired Systolic Pressure

If your systolic pressure is expected to exceed 230 mmHg, use this procedure.

1. Place the cuff on the arm (preferably the left arm).
2. Press and hold the **START** button until a number about 30 to 40 mmHg higher than your expected systolic pressure appears.
3. Release the **START** button to start measurement, when the desired number is reached. Then continue to measure your blood pressure as described on the previous page.

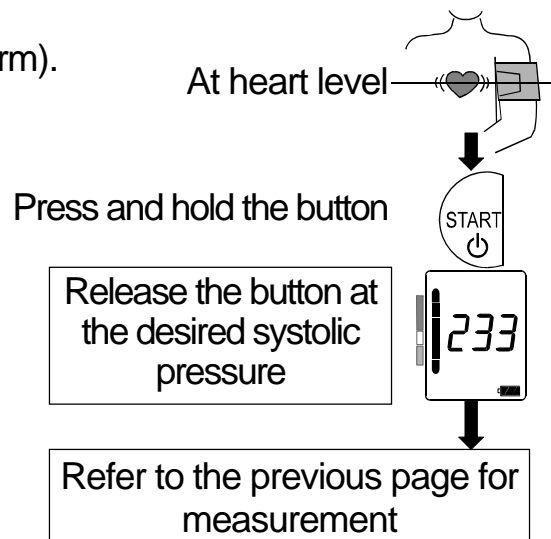

Notes For Proper Measurement

- Sit down in a comfortable position. Place the arm to be used for the measurement on a table or other support so that the center of the cuff will be at the same height as your heart.
- Relax for about five or ten minutes before taking a measurement. If you are excited or depressed by emotional stress, the measurement will reflect this stress as a higher (or lower) than normal blood pressure reading and the pulse reading will usually be faster than normal.
- An individual's blood pressure varies constantly, depending on what you are doing and what you have eaten. What you drink can have a very strong and rapid effect on your blood pressure.
- This device bases its measurements on the heartbeat. If you have a very weak or irregular heartbeat, the device may have difficulty determining your blood pressure.
- Should the device detect a condition that is abnormal, it will stop the measurement and display an error symbol. Refer to page 4 for the description of symbols.
- This device is intended for use by adults only. Consult with your physician before using this device on a child. A child should not use this device unattended.

Recalling Memory Data

Note: This device stores the last sixty measurements in memory automatically. The data is retained as long as the batteries are in the device. When you remove the batteries or the batteries are drained, the data will be erased.

1. Press the **MEMORY** button.
2. The date and the most recent data are displayed.
3. When the **MEMORY** button is pressed while data is displayed, the previous data is displayed.
4. After the last data is displayed, the display goes blank.
5. Press and hold the **MEMORY** button until the “M” (memory) mark blinks to clear the stored data.

Press the **MEMORY** button

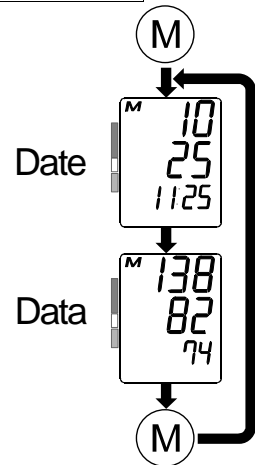

Note: Pressing the **START** button while the memory data is displayed, the device starts.

What Is An Irregular Heartbeat

Model UA-789XL provides a blood pressure and pulse rate measurement even when an irregular heartbeat occurs. An irregular heartbeat is defined as a heartbeat that varies by 25% from the average of all heartbeats during the blood pressure measurement. It is important that you be relaxed, remain still and do not talk during measurements.

Note: We recommend contacting your physician if you see this (♥) indicator frequently.

Pressure Bar Indicator

The indicator monitors the progress of pressure during measurement.

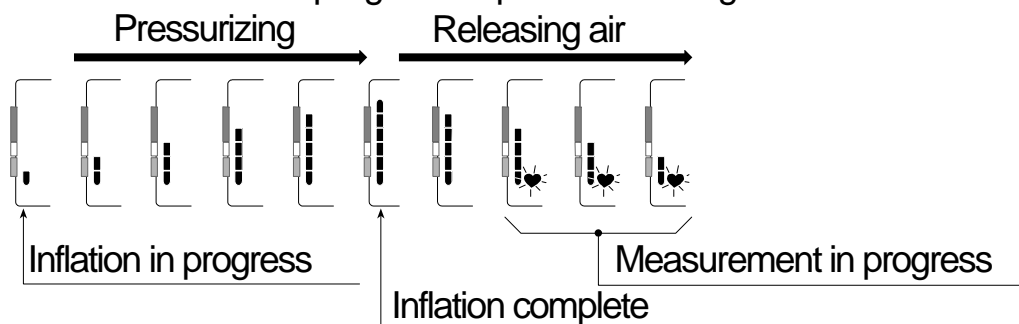

WHO Classification Indicator

Each segment of the bar indicator corresponds to the WHO blood pressure classification described on the next page.

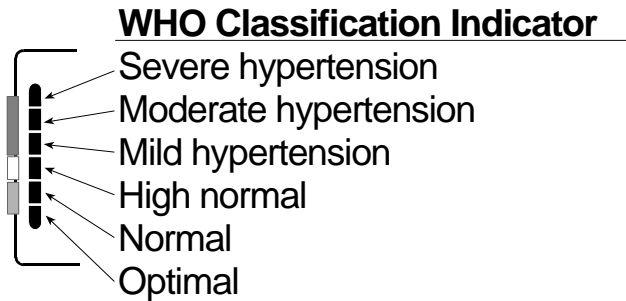

■ : The indicator displays a segment, based on the current data, corresponding to the WHO classification.

Example:

Moderate hypertension

Mild hypertension

High normal

About Blood Pressure

What Is Blood Pressure?

Blood pressure is the force exerted by blood against the walls of the arteries. Systolic pressure occurs when the heart contracts. Diastolic pressure occurs when the heart expands. Blood pressure is measured in millimeters of mercury (mmHg). One's natural blood pressure is represented by the fundamental pressure, which is measured first thing in the morning while one is still at rest and before eating.

What Is Hypertension And How Is It Controlled?

Hypertension, an abnormally high arterial blood pressure, if left unattended, can cause many health problems including stroke and heart attack. Hypertension can be controlled by altering lifestyle, avoiding stress, and with medication under a doctor's supervision.

To prevent hypertension or keep it under control:

- Do not smoke
- Reduce salt and fat intake
- Maintain proper weight
- Exercise regularly
- Have regular physical checkups

Why Measure Blood Pressure At Home?

Blood pressure measured at a clinic or doctor's office may cause apprehension and can produce an elevated reading, 25 to 30 mmHg higher than that measured at home. Home measurement reduces the effects of outside influences on blood pressure readings, supplements the doctor's readings and provides a more accurate, complete blood pressure history.

WHO Blood Pressure Classification

Standards to assess high blood pressure, without regard to age, have been established by the World Health Organization (WHO), as shown in the chart.

Blood Pressure Variations

An individual's blood pressure varies greatly on a daily and seasonal basis. It may vary by 30 to 50 mmHg due to various conditions during the day. In hypertensive individuals, variations are even more pronounced. Normally, the blood pressure rises while at work or play and falls to its lowest levels during sleep. So, do not be overly concerned by the results of one measurement.

Take measurements at the same time every day using the procedure described in this manual to get to know your normal blood pressure. Regular readings give a more comprehensive blood pressure history. Be sure to note date and time when recording your blood pressure. Consult your doctor to interpret your blood pressure data.

Reference Material: Journal of Hypertension 1999, Vol 17 No.2

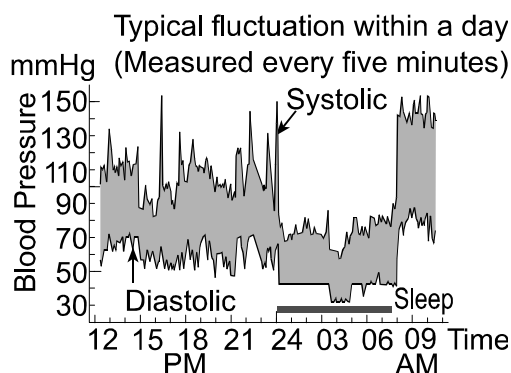
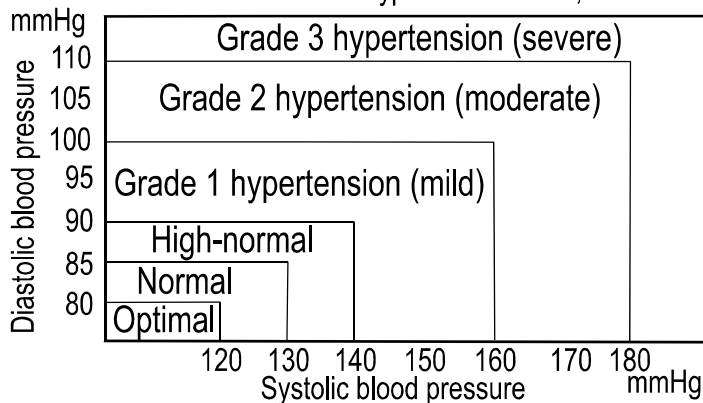

Troubleshooting

Problem	Possible Reason	Recommended Action
Nothing appears on the display, even when the power is turned on.	Batteries are drained.	Replace all batteries with new ones.
	Battery terminals are not in the correct position.	Reinstall the batteries with negative and positive terminals matching those indicated on the battery compartment.
The cuff does not inflate.	Battery voltage is too low.  (LOW BATTERY mark) blinks. [If the batteries are drained completely, the mark does not appear.]	Replace all batteries with new ones.
The device does not measure. Readings are too high or too low.	The cuff is not fastened properly.	Fasten the cuff correctly.
	You moved your arm or body during the measurement.	Make sure you remain very still and quiet during the measurement.
	The cuff position is not correct.	Sit comfortably and still. Raise your hand so that the cuff is at the same level as your heart.
	_____	If you have a very weak or irregular heart beat, the device may have difficulty in determining your blood pressure.
Other	The value is different from that measured at a clinic or doctor's office.	Refer to "Why measure blood pressure at home".
	_____	Remove the batteries. Place them back properly and try the measurement again.

















Note: If the actions described above do not solve the problem, contact the dealer. Do not attempt to open or repair this product, as any attempt to do so will make your warranty invalid.

Maintenance

Do not open the device. It uses delicate electrical components and an intricate air unit that could be damaged. If you cannot fix the problem using the troubleshooting instructions, request service from your dealer or from the A&D service group. The A&D service group will provide technical information, spare parts and units to authorized dealers.

The device was designed and manufactured for a long service life. However it is generally recommended to have the device inspected every 2 years, to ensure proper functioning and accuracy. Please contact either your authorized dealer or A&D for maintenance.

Technical Data

Type	UA-789XL
Measurement method	Oscillometric measurement
Measurement range	Pressure: 20 - 280 mmHg Pulse: 40 - 200 beats / minute
Measurement accuracy	Pressure: ± 3 mmHg Pulse: $\pm 5\%$
Power supply	4 x 1.5V batteries (R6P, LR6 or AA) or AC adapter (TB-242)(Not included)
Number of measurements	Approximately 200 measurements, when AA Alkaline batteries are used, with pressure value of 180 mmHg at room temperature of 23 °C.
Classification	Internally powered ME equipment (Supplied by batteries) / Class II (Supplied by adapter) Continuous operation mode
Clinical test	According to ANSI / AAMI SP-10 1987
EMC	IEC 60601-1-2: 2007
Memory	Last 60 measurements
Operating condition	+10 °C to +40°C / 15 %RH to 85 %RH / 800 hPa to 1060 hPa
Transport / Storage condition	-10 °C to +60°C / 15 %RH to 95 %RH
Dimensions	Approx. 163 [W] x 62 [H] x 112 [D] mm
Weight	Approx. 360 g, excluding the batteries
Applied part	Cuff Type BF 
Useful life	Device: 5 years (when used six times a day) Cuff: 2 years (when used six times a day)
Accessory AC adapter	The adapter is to connect the device to a power source at home.
TB-242	Please contact your local A&D dealer for purchasing. The AC adapter is required to be inspected or replaced periodically.
TB-242C	Input: 100-240V Output: 6V  2A    CB FC    
TB-242BF	Input: 240V Output: 6V  2A    CB FC    

Accessories sold separately

Cuff

Catalog Number	Cuff Size	Arm Size
CUF-D-LA	Large adult cuff	32 cm to 45 cm
CUF-B-XLA	Extra larg adult cuff	42 cm to 60 cm

Arm size: The circumference at the biceps.

AC adapter

Catalog Number	Plug (Outlet type)
TB-242C	Type C
TB-242BF	Type BF

Note: Specifications are subject to change without prior notice.

EMC table information is listed on our website:

http://www.aandd.jp/products/manual/medical/emc_acadapter_en.pdf



A&D Company, Limited

Asahi 1-243, Kitamoto-shi, Saitama 364-8585, JAPAN
Telephone: [81] (48) 593-1111 Fax: [81] (48) 593-1119

EC REP A&D INSTRUMENTS LIMITED

Unit 24/26 Blacklands Way, Abingdon Business Park, Abingdon, Oxfordshire
OX14 1DY United Kingdom
Telephone: [44] (1235) 550420 Fax: [44] (1235) 550485

A&D ENGINEERING, INC.

1756 Automation Parkway, San Jose, California 95131, U.S.A.
Telephone: [1] (408) 263-5333 Fax: [1] (408)263-0119

A&D AUSTRALASIA PTY LTD

32 Dew Street, Thebarton, South Australia 5031, AUSTRALIA
Telephone: [61] (8) 8301-8100 Fax: [61] (8) 8352-7409