

Table Top Universal Testing Machine

Force Tester

MCT Series



A&D

A&D Company, Limited

<http://www.aandd.jp>

...Clearly a Better Value

Strength you can see!

Easy to operate with precision color touch panel.

General purpose **MCT-1150**
Load display resolution: 0.1N

High performance **MCT-2150**
Load display resolution: 0.01N

Compact

Space-saving design allows for table top use (250(W)×405(D)×711(H)mm).

No hassle start up

Automatic calibration on start up means no waiting around. (Load cell calibration unnecessary)

High precision load cell included

Use with your favorite jigs

Use jigs from companies other than A&D as well.

*When using the M6 male screw adapter



Simple USB connection



*Picture shows spring measurement

*PC sold separately

Ideal for use in the field

Easily adjust digital testing speed in 1mm/min increments.
Standard displacement display.

Use only the touch panel to operate

Crisp, clear touch panel is easy to operate.

Data capture software included

Supported OS: Windows XP, Vista Business, 7Pro (32bit version)
USB: Ver 2.0 or higher

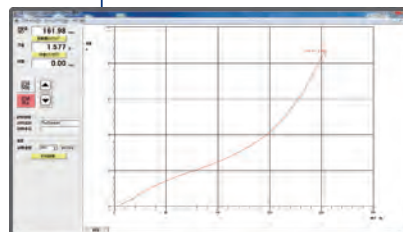

MCT-Logger [Recording software]

Real-time graphing.
Calculate and display maximum value and displacement.
Or enter curve data in CSV format.

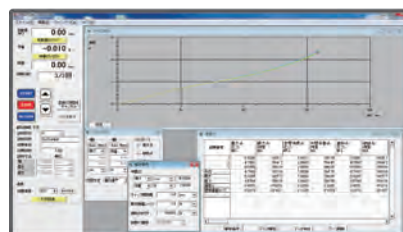

MSAT-Lite [Data processing software]

Displays operation and processing results.
Performs data analysis and graphing.
Or enter curve data in CSV format.

Easy to operate touch panel

Main screen



Manual operation screen

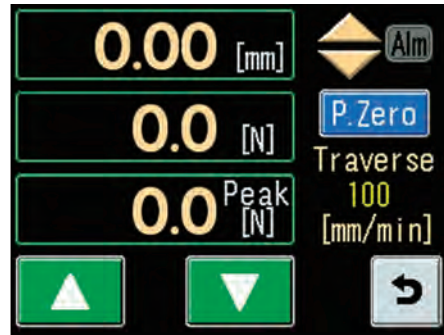

Speed setting input screen



Test condition settings screen

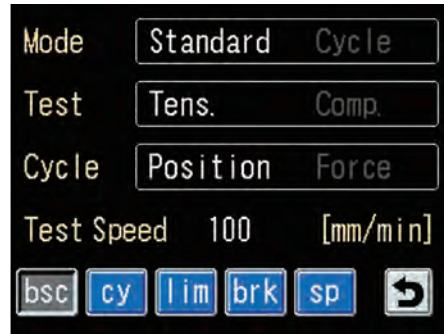

Menu/alarm setting screen



Cycle test settings

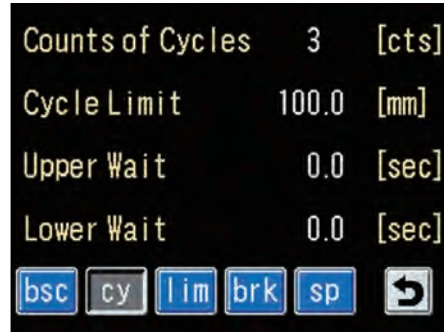

Limit settings



Switch push force test



Heat seal peel strength test

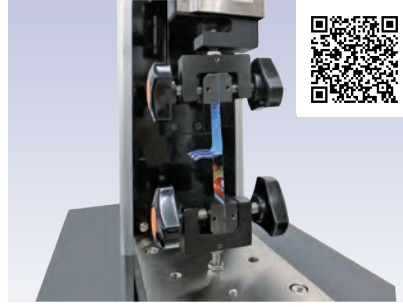

Electronic component tensile strength test



Packing container compressive strength test



Plastic bottle compressive strength test



Packing container puncture resistance test

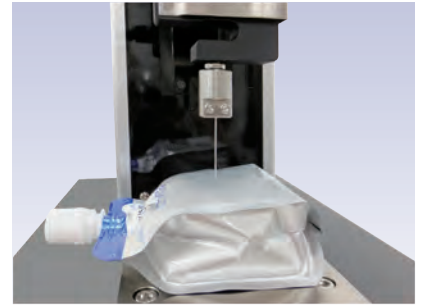

Tensile strength test

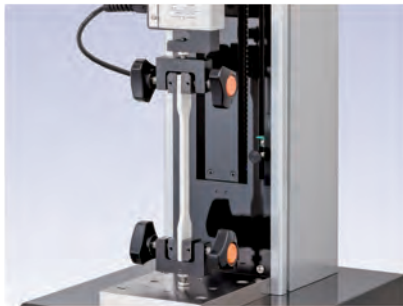

Food packaging puncture test



Container seal peeling test

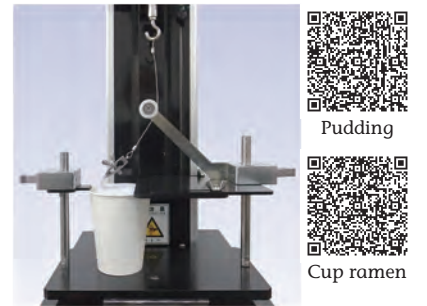

Pudding



Cup ramen

Medicine PTP packaging push force test

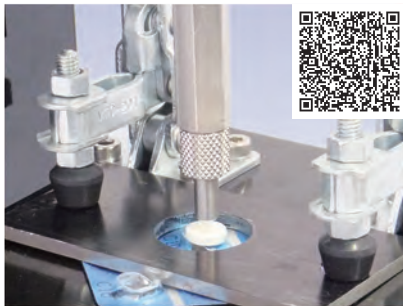

Syringe resistant test

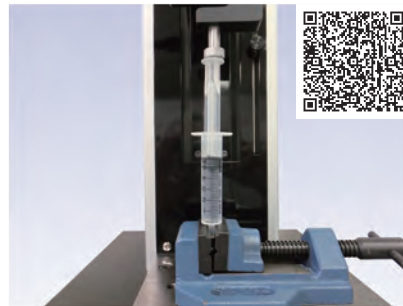

Tablet strength test

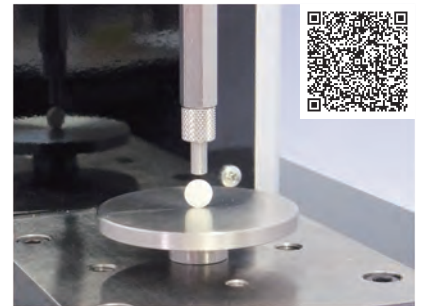

Sheet metal bending strength test

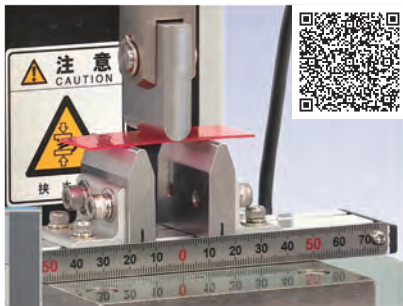

Safety cover



A safety cover can be installed to prevent samples from being scattered during measurement.

Accessories

Optional jigs

① JM-JFM-500N	Screw action jaws (Not sold as a bottom/top pair)	Maximum load 500N Price for one piece. An upper and lower jaw are necessary for tensile strength tests. Face dimensions 19 (w) x 19 (h) mm, opening width 10 mm. The face side is knurled.
② J-C3-1KN-U	Load sensitive plates for STA/STB For 1KN/500N/50N Ø60mm	Maximum load 500N Price for one piece. An upper and lower jaw are necessary for compression tests.
③ JM-B-500N	R2 Bending test jig	Maximum load 500N Lower fulcrum R2 Upper fulcrum R5. Bottom span between 10 and 110 mm.
JM-B1-500N	R5 Bending test jig	Maximum load 500N Lower fulcrum R5 Upper fulcrum R5. Bottom span between 10 and 110 mm.
JM-X001-500N	Attachment set (Items with ★ included)	Maximum load 500N Attachment set.
④ JM-X002-500N ★	Hook	Maximum load 500N Hook inner diameter 10 mm. The hook opening is 6 mm allowing string-shaped objects with a diameter of 6 mm or less to be hooked.
⑤ JM-X003-500N ★	V groove indenter	Maximum load 500N Tip V Groove angle 90°, diameter 10 mm, length 20 mm
⑥ JM-X004-500N ★	Load sensitive plate Ø15mm	Maximum load 500N Tip diameter 15 mm, height 16 mm
⑦ JM-X005-500N ★	Cone indenter	Maximum load 500N Tip cone 90°, diameter 10 mm, length 20 mm
⑧ JM-X006-500N ★	Cone indenter	Maximum load 500N Tip edge angle 60°, blade width 10 mm, diameter 10 mm, length 20 mm
⑨ JM-X007-500N ★	Extension rod	Maximum load 500N Used to extend hooks and attachments. Length 80 mm, M6 female screw 14 mm depth to fix attachment
⑩ JM-X008-500N	Load sensitive plate Ø5mm	Maximum load 500N Tip diameter 5 mm, height 20 mm Used when compressing small objects.
⑪ JM-X009-500N	M6 Male screw adapter	Maximum load 500N Used to fix M6 female screw jigs or attachments.
⑫ JM-X010	Lower adapter	Maximum load 500N Used to shift the position of lower jigs.
⑬ JM-X011	MCT vice	Maximum load 500N Open width max 30 mm.
⑭ JM-X012	MCT safety cover	Safety cover for preventing scattering of materials. Made of acrylic.
⑮ JM-X013	MCT jaw stand for Tensilon jigs	Maximum load 500N Jaw stand for use with Tensilon testing jigs. Fixed by pin.
⑯ JM-X014	Pin Chuck (100N)	Maximum load 100N Same as pin vice. Grip pin diameter max 3.2 mm.
⑰ JM-CL-100N	MCT Puncture Test Jig	Maximum load 100N Used for film piercing tests. Comes with 1 needle (Ø1 mm, tip R 0.5mm).
JM-CL-100N-01	Puncture Test Jig replacement needles (10 piece set)	Replacement for the above needle Diameter 1 mm, tip R 0.5mm.
⑱ JM-JXM-250N	Pin Chuck (250N)	Maximum load 250N Small parallel clamping jaw Tip width 2 mm Ideal for peeling tests.
⑲ JM-PZ-50N	Container seal peeling test jig	Maximum load 50N Used for container lid seal peel strength measurement. Peels at approx. 45°.

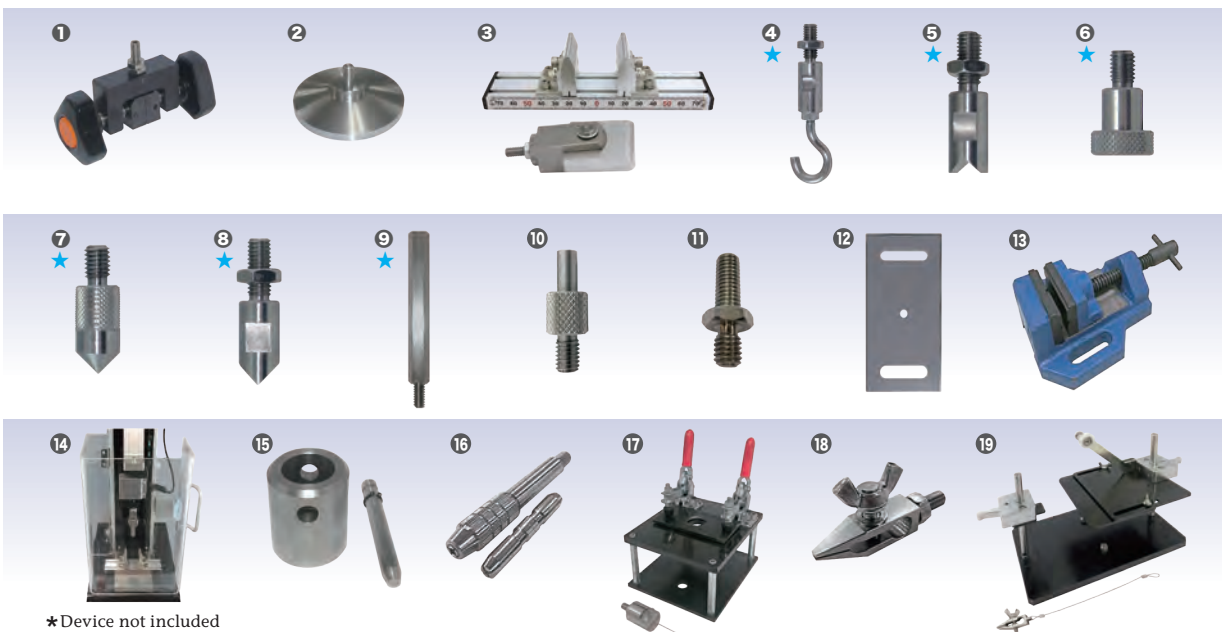

Specifications

Model	MCT-1150 General purpose model	MCT-2150 High performance model
Table / floor model	Table model	
Maximum capacity	500N	
Crosshead stroke	400mm	370mm
Effective stroke *1	315mm	285mm
Crosshead speed	10-300mm/min: Within 5% of the set value *2	
Crosshead speed setting	Digital setting: 1mm/min increments within the above range	
Crosshead speed and load capacity	Full speed range at maximum capacity	
Crosshead return speed	Three speed settings: 10, 100, 300mm/min	
Load measurement accuracy	±0.2% F.S	500N~50N : ±0.2% F.S 50N~5N : Within 2% of indicator value 5N and lower : Within 0.1N
Load display resolution	0.1N	0.01N (0.1N will display for values over 100N)
Load calibration	Auto-zero function (calibration unnecessary)	
Displacement display	000.0mm (Min. 0.1mm)	00.00mm (Min 0.01mm : 0.1mm will display for values over 100mm)
Included software	MCT-Logger	MSAT-Lite
Safety mechanisms	1. Upper and lower displacement stroke limits 2. Overload limit (automatic shutdown when load cell passes 105% of rated capacity) 3. Emergency stop switch	
Dimensions (W × D × H)	250 × 405 × 711mm	
Weight	17kg	18kg
Power supply	AC90~240V 1Ø 50/60Hz	
Power consumption	90W	
Operating ambient conditions	Temperature : 5~40°C Humidity : 20~80%RH	
Recommended ambient conditions	Temperature : 23±2°C Humidity : 50±10%RH	
Standard equipment	Instruction manual, 500N capacity load cell, computer software (CD-ROM), USB cable	

*1 When using standard screw action jaws *2 Unladen

External dimensions Unit: mm

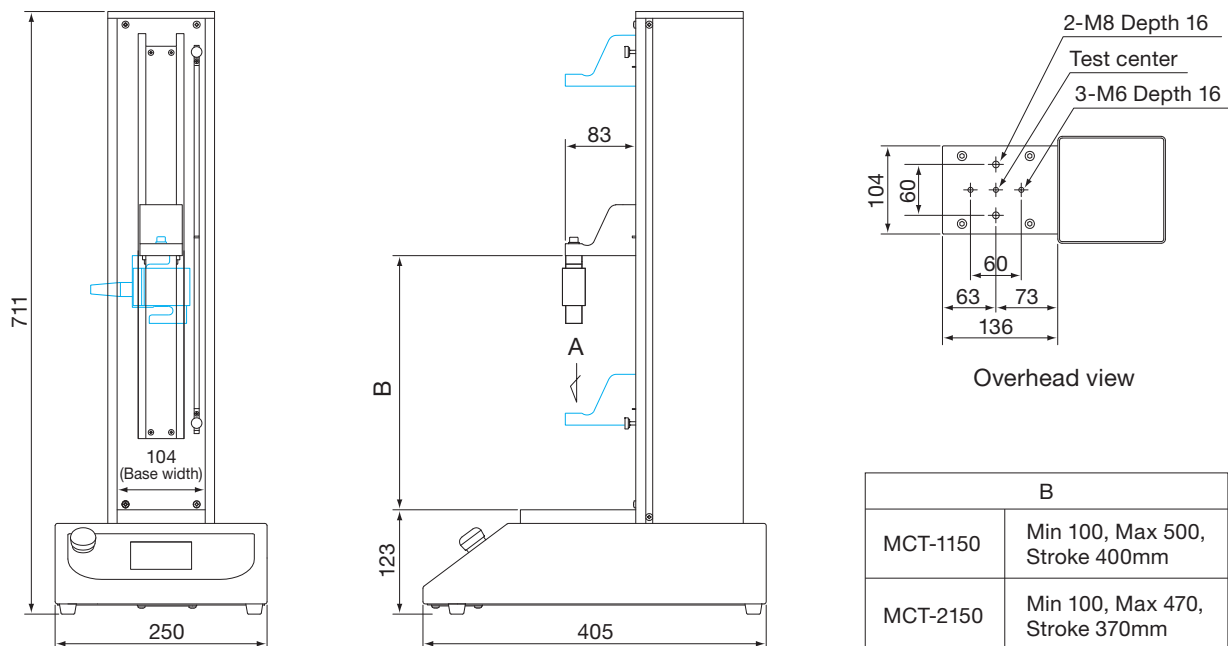

A&D Company, Limited
 3-23-14 Higashi-Ikebukuro, Toshima-ku, Tokyo 170-0013 JAPAN
 Telephone: [81](3) 5391-6132 Fax: [81](3) 5391-6148
 http://www.aandd.jp

	Attention to Safety!	● For proper use, read the instruction manuals carefully before use
--	-----------------------------	---

● Appearance and/or specifications subject to change for improvement without notice.
 ● Contents of this catalog last updated May 2017.